

Arced Cabinet Pull 25-Pack
Satin Nickel

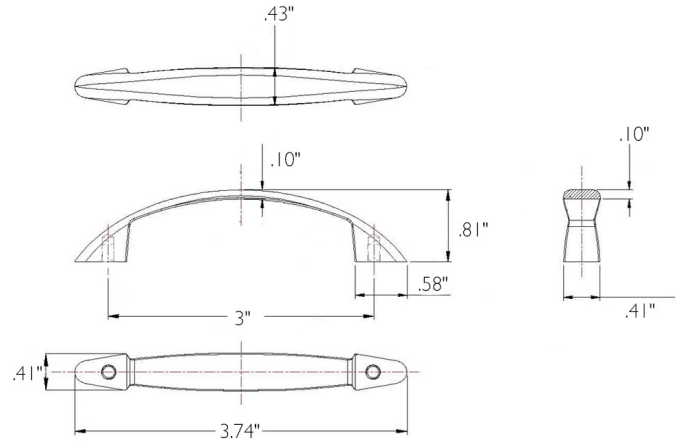

SPECIFICATIONS

MATERIAL CONSTRUCTION:	Zinc
MOUNTING HARDWARE INCLUDED:	Yes
TOOLS NEEDED FOR INSTALLATION:	Screwdriver
ASSEMBLED DIMENSIONS:	0.81" H x 3.74" L
CENTER TO CENTER:	3"
LEVER/PULL LENGTH:	N/A
PROJECTION:	0.81"
KNOB DIAMETER:	N/A
ASSEMBLED WEIGHT:	0 lbs.

WARRANTY: 1-Year limited warranty
 LEGAL FOR SALE IN CALIFORNIA: Yes



TYPE:
 JOB:
 ORDER CODE:
 APPROVALS: