

Standard Hinge Pin Door Stop 5-Pack
Polished Brass

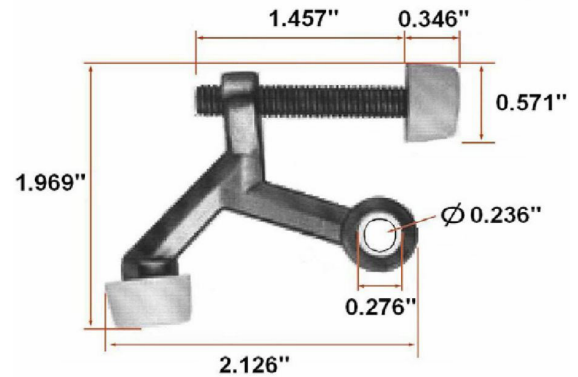

SPECIFICATIONS

MATERIAL CONSTRUCTION:	Zinc
MOUNTING HARDWARE INCLUDED:	Yes
TOOLS NEEDED FOR INSTALLATION:	N/A
ASSEMBLED DIMENSIONS:	1.97" H x 2.126" L x .57" D
ASSEMBLED WEIGHT:	1 lbs.
CROSS BORE:	N/A
CORNER RADIUS:	N/A
PROJECTION:	N/A
HINGE TYPE:	N/A
NUMBER OF HOOKS:	N/A

WARRANTY: 1-Year limited warranty

LEGAL FOR SALE IN CALIFORNIA: Yes



TYPE:
JOB:
ORDER CODE:
APPROVALS: