

# Eastport Semi-Flush Pendant Light



## Specifications

<b>Material Construction:</b>	Steel
<b>Lens:</b>	Frosted White Glass
<b>Lamp Type &amp; Wattage:</b>	3 50W GU10 Base MR16 Lamps
<b>Mounting:</b>	Ceiling Mount
<b>Finish</b>	Polished Chrome
<b>Voltage:</b>	120V
<b>Weight:</b>	6lbs



## Dimensions

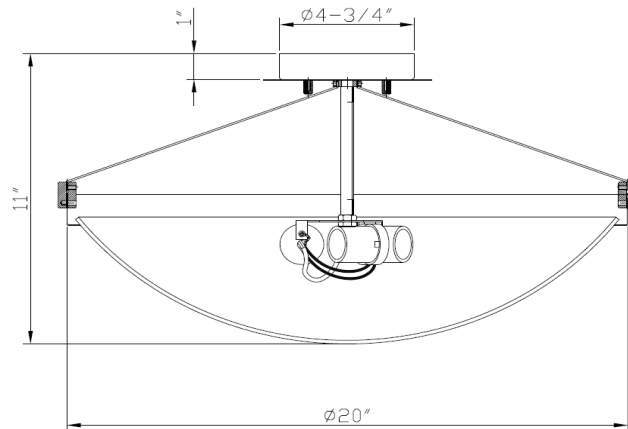







## Warranty & Compliances

<b>Warranty</b>	10 Year Limited Warranty
<b>UL</b>	UL/cUL listed for damp location
<b>ADA</b>	N/A
<b>EnergyStar</b>	N/A



## Companion Fixtures

Order Code	Finish	Bulb
828350 	Polished Chrome	3 x 60w medium base
828426 	Polished Chrome	3 x 13w GU24 base
828368 	Satin Nickel	3 x 60w medium base
828376 	Satin Nickel	3 x 13w GU24 base
828418 	Brushed Bronze	3 x 60w medium base
828434 	Brushed Bronze	3 x 13w GU24 base

**Type:**  
**Job:**  
**Order Code:**  
**Approvals:**



**Indicates product is manufactured for use in damp locations.**

Design House reserves the right to make changes in materials, specifications & models at any time. Design House also reserves the right to discontinue product without notice or obligation.