

Eastport Semi-Flush Pendant Light



Specifications

Material Construction:	Steel
Lens:	Frosted White Glass
Lamp Type & Wattage:	3 50W GU10 Base MR16 Lamps
Mounting:	Ceiling Mount
Finish	Polished Chrome
Voltage:	120V
Weight:	6lbs



Dimensions

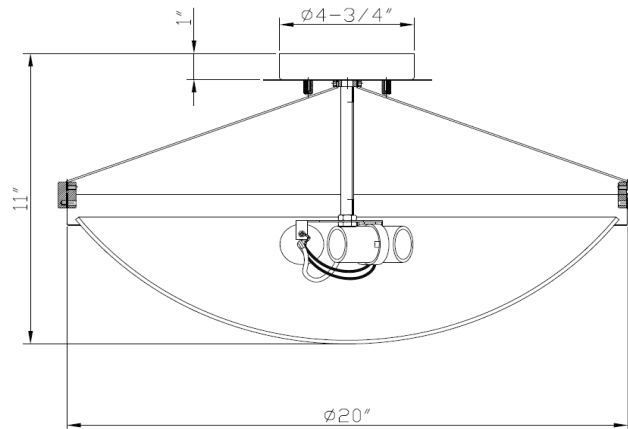







Warranty & Compliances

Warranty	10 Year Limited Warranty
UL	UL/cUL listed for damp location
ADA	N/A
EnergyStar	N/A



Companion Fixtures

Order Code	Finish	Bulb
828350 	Polished Chrome	3 x 60w medium base
828426 	Polished Chrome	3 x 13w GU24 base
828368 	Satin Nickel	3 x 60w medium base
828376 	Satin Nickel	3 x 13w GU24 base
828418 	Brushed Bronze	3 x 60w medium base
828434 	Brushed Bronze	3 x 13w GU24 base

Type:
Job:
Order Code:
Approvals:



Indicates product is manufactured for use in damp locations.

Design House reserves the right to make changes in materials, specifications & models at any time. Design House also reserves the right to discontinue product without notice or obligation.