

GENERAL INSTALLATION INSTRUCTION

Notes: This instruction is for all this type of mixer, the mixer picture in this instruction is for showing how to install only.

SPREAD FAUCET

BEFORE INSTALLATIONS

1. Please read these instructions carefully and install in turn to avoid unnecessary damage due to improper installation.
2. Please check if the product is in a good state after opening its package. The required tools and materials shall be prepared by yourself not by the product.
3. All information is based on the latest product information available at the time of publication. We reserve the right to make changes in product characteristics, packaging or availability at anytime without notice.
4. Please well keep the following instructions including Attention, Installations, User's attentions and so on.
5. All illustration and dimensions provided by these instructions are only for reference. For actual installations, please refer to the actual product.
6. Before installing and using this product, user shall carefully read and distinctly understand the related content in these instructions. install and use it strictly following the instructions.

RECOMMENDED TOOLS AND MATERIALS



Pipe Sealing Tape

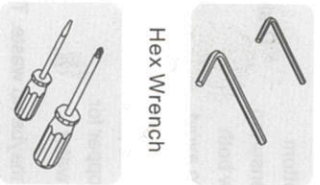

Hex Wrench

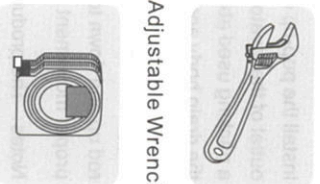

Adjustable Wrench



Pipe Wrench

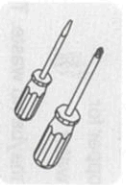

Flathead Screwdriver,
Phillips Screwdriver



Tape Measure

ATTENTIONS

Please read the followings before installing and usage.

1. To avoid blockage, please remove all impurities in pipes before installations.
2. Connect to appropriate water supplies with hot water supply on the left side and cold on the right side.
3. To assure proper installation, check the installation dimensions per Installation Dimensions.
4. The temp. of hot water shall not be higher than 71°C.

DIMENSIONS

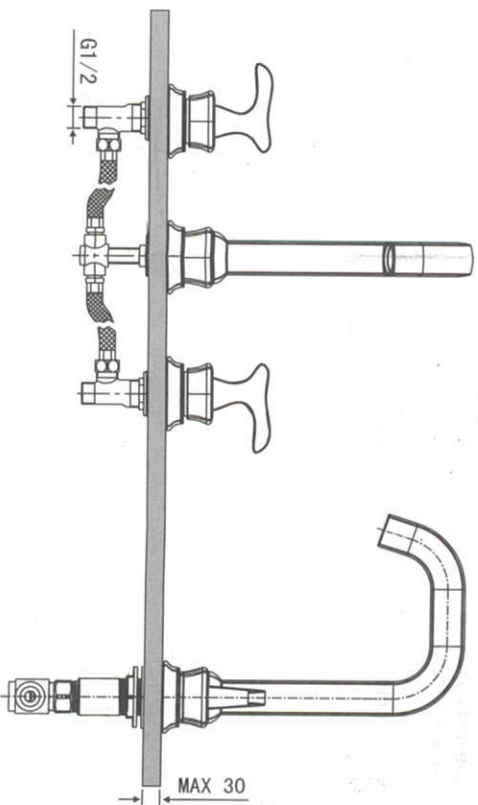

■ For Reference only (unit = mm)

INSTALLATION

1 How to locate the faucet.

To install the faucet cut a mounting hole 35mm in diameter into the bench surface. Remove the components (mounting nut and washers) which are attached to the bottom of the faucet. Install the faucet into the pre-drilled hole ensuring the washer is placed between the trim ring and the bench surface.

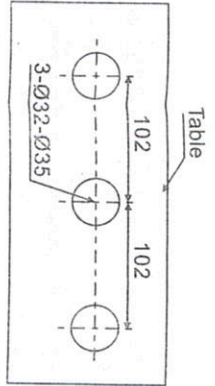

2 How to Install Spout

Install the fitting of the spout from bottom to top. Then insert the spout into the fixing hole and adjust the position. Fasten the bolts with wrench and fix the spout on the desk.

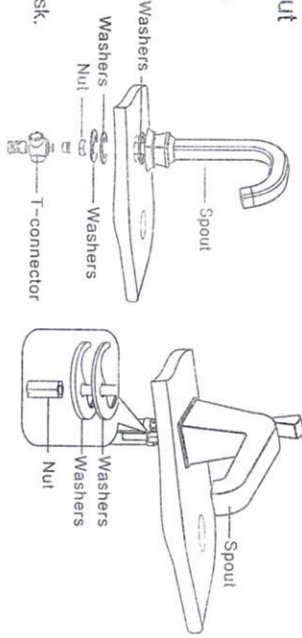

3 How to Install valves

Take down the handle and the nut. Insert valve assembly through the mounting hole from above and turn on the nut from above to appropriate position.

Secure the valve on the deck by tightening nut from below with wrench after appropriately adjusting.

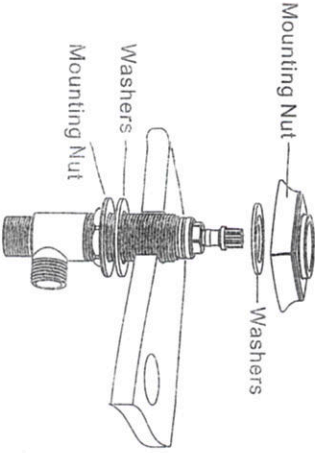

4 How to install the handle

As shown, install parts and fasten the handle on the valve core with screw. Rotate the handle to check if it is in order.

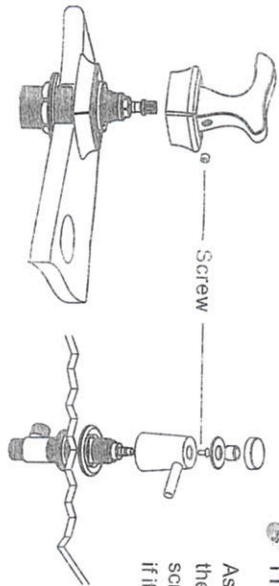

5 How to Install hose

Connect valve body and spout with hose as shown on picture. Connect water supply lines to bottom openings of handle valve stems.

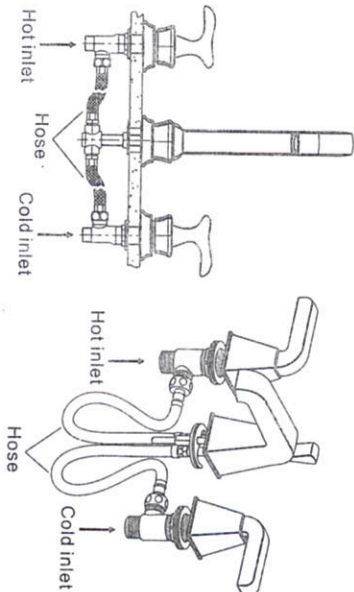

6 How to Install a Pop Up Waste

Install the pop-up drain in the bottom outlet of the lavatory as shown ensuring a packing used above and below both the drain body and the lavatory to avoid leakage. Connect to drain pipe with stopper in. After installation, pull the pull rod up and down to check the stopper for proper movement and stopping water

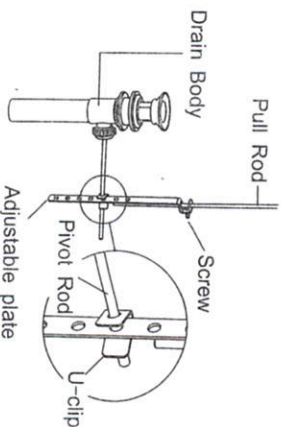

Notes: The product you bought maybe no waste. This is for reference only.
Check: Turn on the faucet and flush through water in order to remove impurities and check for any leaks.