

Commercial Ball Knobs 2-3/4" Latch (Entry)



Specifications

Latch Type	2-3/4"
Door Prep	Cross bore 2-1/8" dia (54mm). Edge bore 9/10" dia (23.8mm)
Backset	2-3/4"
Door Thickness	1-3/8" - 1-3/4" door standard
Cylinder	Rekeyable 6 pins tumbler
Faceplate	Square corner steel faceplate, stainless steel
Strike	Square corner strike, stainless steel
Latch Bolt	Satin stainless steel latch bolt
Door Handing	Reversible for Left or Right hand doors.
Keyway	KW1
Keyed Alike	N/A



Dimensions

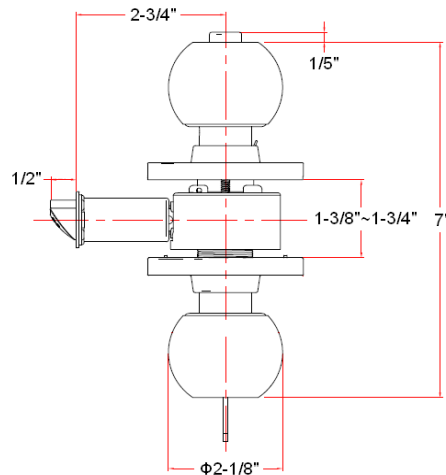

Warranty & Compliances

Warranty	Limited Lifetime Mechanical / 5 year Finish
ANSI/BHMA	Meets ANSI Grade 2 specification
ADA	N/A
UL	Meets UL Fire specification (3 hours)



Order Codes

Box Pack

Satin Nickel (US15) 701680



Type:

Job:

Order Code:

Approvals:

Design House reserves the right to make changes in materials, specifications & models at any time. Design House also reserves the right to discontinue product without notice or obligation.