



IMPALA 1LT WALL MOUNT & 3LT VANITY LIGHT ASSEMBLY/INSTALLATION INSTRUCTIONS

Please read carefully and save these instructions, as you may need them at a later date.

CAUTION

Turn off the main power at the circuit breaker before installing the fixture, in order to prevent possible shock.

GENERAL

All electrical connections must be in accordance with local and National Electrical Code (N.E.C.) standards. If you are unfamiliar with proper electrical wiring connections obtain the services of a qualified electrician.

Remove the fixture and the mounting package from the box and make sure that no parts are missing by referencing the illustrations on the installation instructions.

TOOLS REQUIRED

Philips Screwdriver.

ASSEMBLY AND INSTALLATION

Turn off the power at fuse or circuit breaker.

1. Before beginning the installation, carefully unpack and identify all parts.
2. Using (2) JUNCTION BOX SCREWS, securely fasten the CROSSBAR to the JUNCTION BOX.
3. **MAKE THE CONNECTIONS:** Attach the FIXTURE GROUND WIRE to the CROSS BAR with GREEN GROUND SCREW. Then connect it to the SUPPLY GROUND WIRE with a wire nut. Using WIRE NUTS, connect the SUPPLY WHITE WIRE(S) to the FIXTURE WHITE (or RIBBED) LEAD(S); Connect the SUPPLY BLACK (or RED) WIRE to the FIXTURE BLACK (or SMOOTH) LEAD(S). Wrap all connections with approved electrical tape.
4. Place the WALL PLATE over the CROSS BAR and secure it with (2) LOCKING BALLS.
5. Put INNER GLASS shade(s) into OUTER GLASS shade(s) carefully and slide over the SOCKET(S). Thread SOCKET RING(S) onto the end of the SOCKET(S). Hand tighten until snug.
6. Install LIGHT BULB(S) (Sold separately), refer to fixture labels for max wattage. The bulb quantities depend on the style (Refer to Figure 2). DO NOT exceed the maximum wattage.

Turn on the power at fuse or circuit breaker.

FIGURE 1.

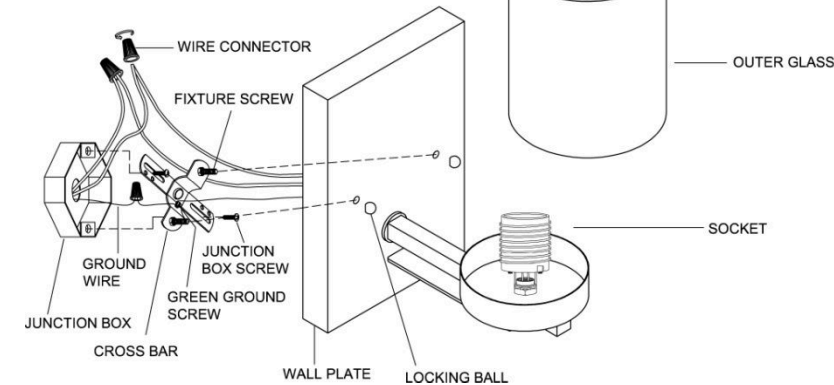
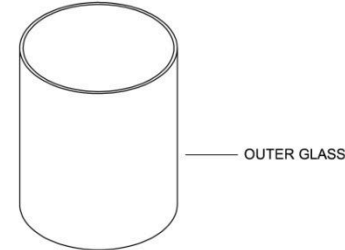
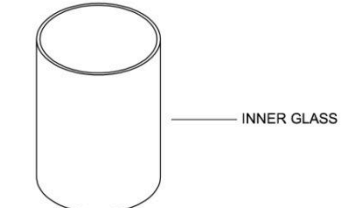
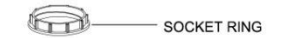
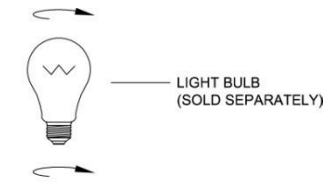
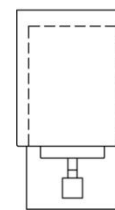
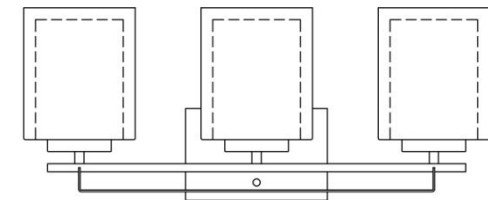

FIGURE 2.



#578153



#578161

**IF IN DOUBT ABOUT ELECTRICAL INSTALLATION,
CONSULT A LICENSED ELECTRICIAN.**

Customer Service: 1-800-558-8700