

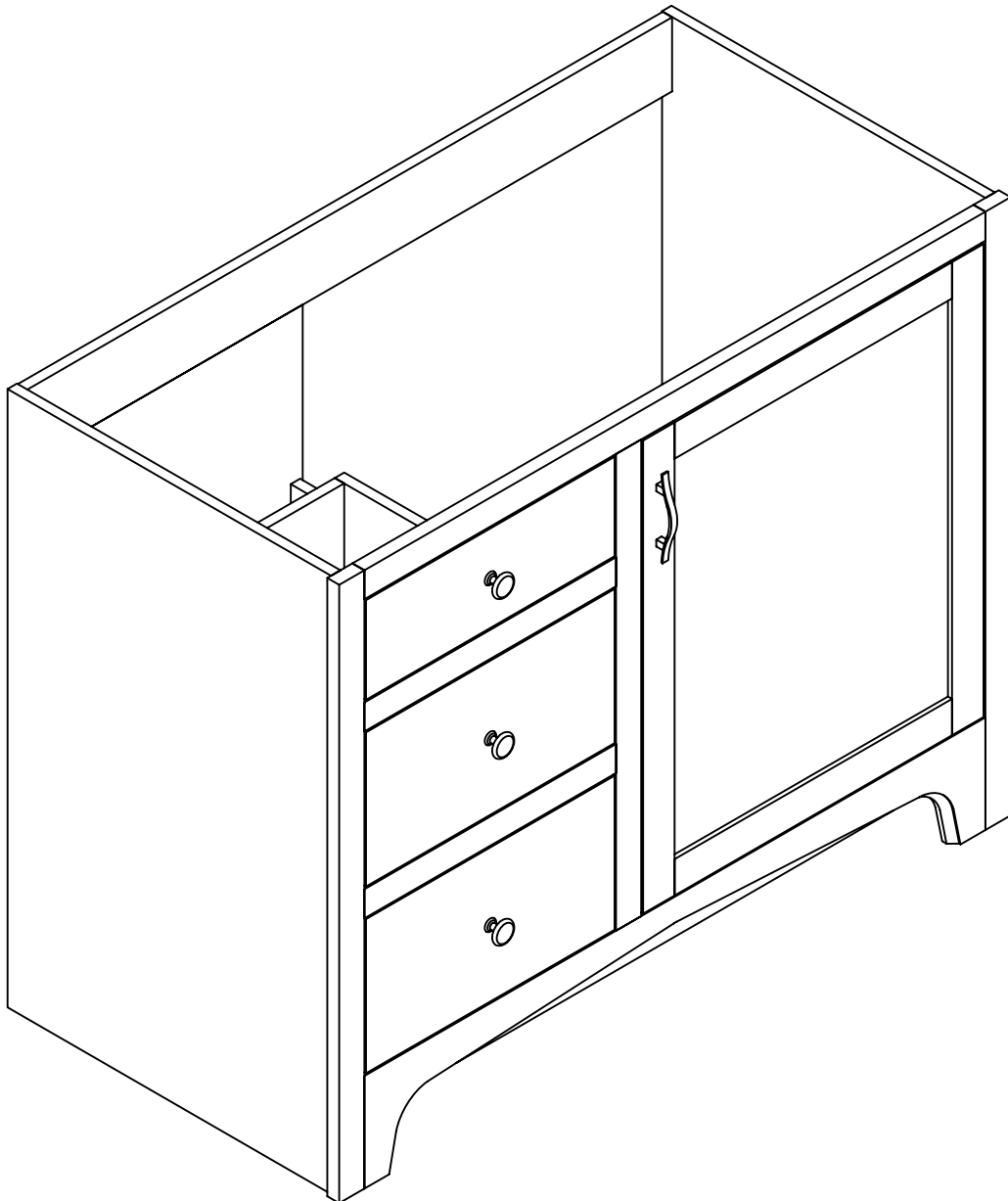

www.todaysdesignhouse.com



541854

ASSEMBLY INSTRUCTIONS

DHI Corp. • 5205 W. Donges Bay Rd. • Mequon, WI 53092 • 800.558.8700

PARTS LIST:

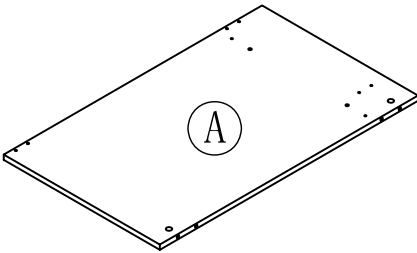

LEFT SIDE
PANEL 1PC

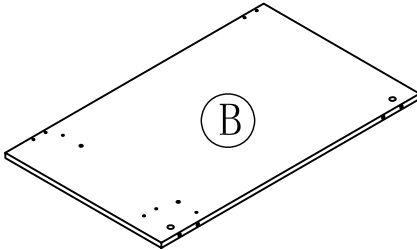

RIGHT SIDE
PANEL 1PC

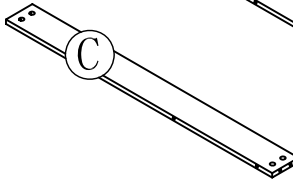

BACK UP CROSS
BRACE 1PC

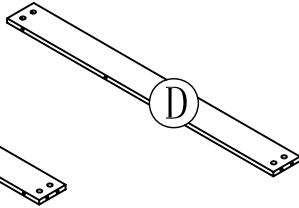

BACK DOWN CROSS
BRACE 1PC

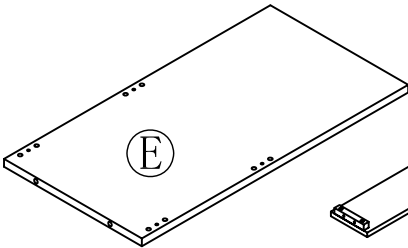

BACK PARTITION
PANEL 1PC

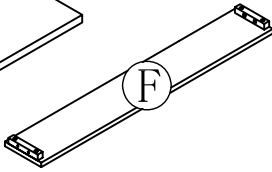

TOE KICK
PANEL 1PC

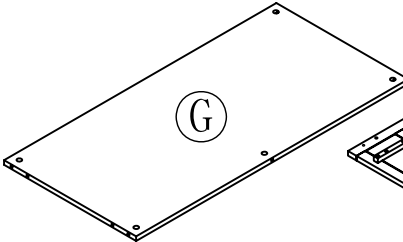

BOTTOM PANEL 1PC

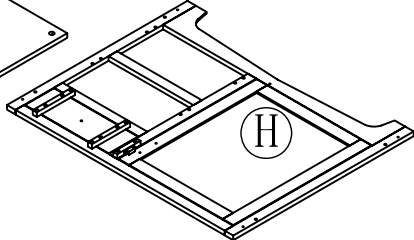

FRONT FRAME 1PC

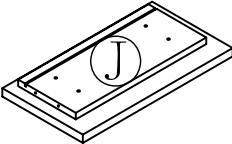

DRAWER FRONT
PANEL 2PCS

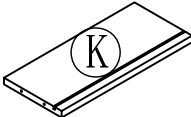

DRAWER BACK
PANEL 2PCS

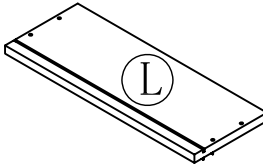

DRAWER LEFT SIDE
PANEL 2PCS

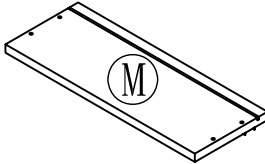

DRAWER RIGHT
SIDE PANEL 2PCS

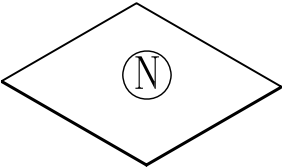

DRAWER BOTTOM
PANEL 2PCS

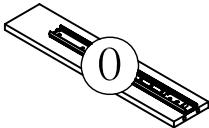

SUPPORT
PANEL 4PCS

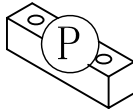

STOPPER 1PC

HARDWARE LIST:



a. WOOD DOWEL 28PCS

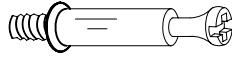

b. CAM LOCK SCREW
17PCS



c. CAM LOCK 17PCS

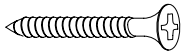

d. 1" L FLAT HEAD
SCREW 10PCS

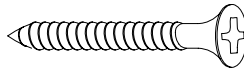

e. 1-1/2" L FLAT HEAD
SCREW 16PCS

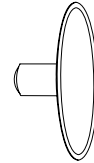

f. PLASTIC COVER
17PCS



g. KNOB 3PCS

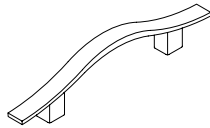

h. HANDLE 1PC

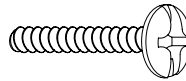

i. HANDLE (KNOB)
BOLT 5PCS

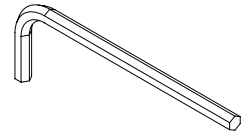

j. WRENCH 1PC

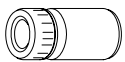

k. GLUE 1PC

STEP 1

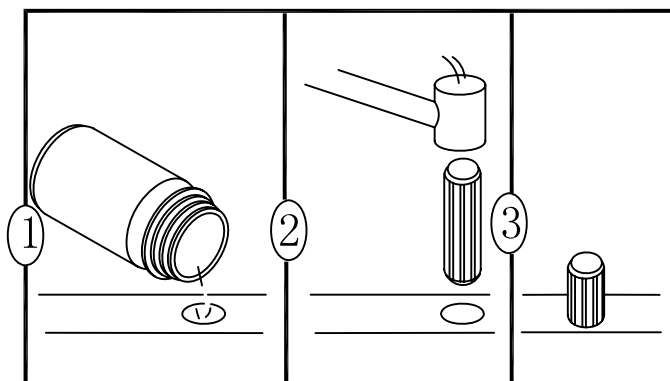
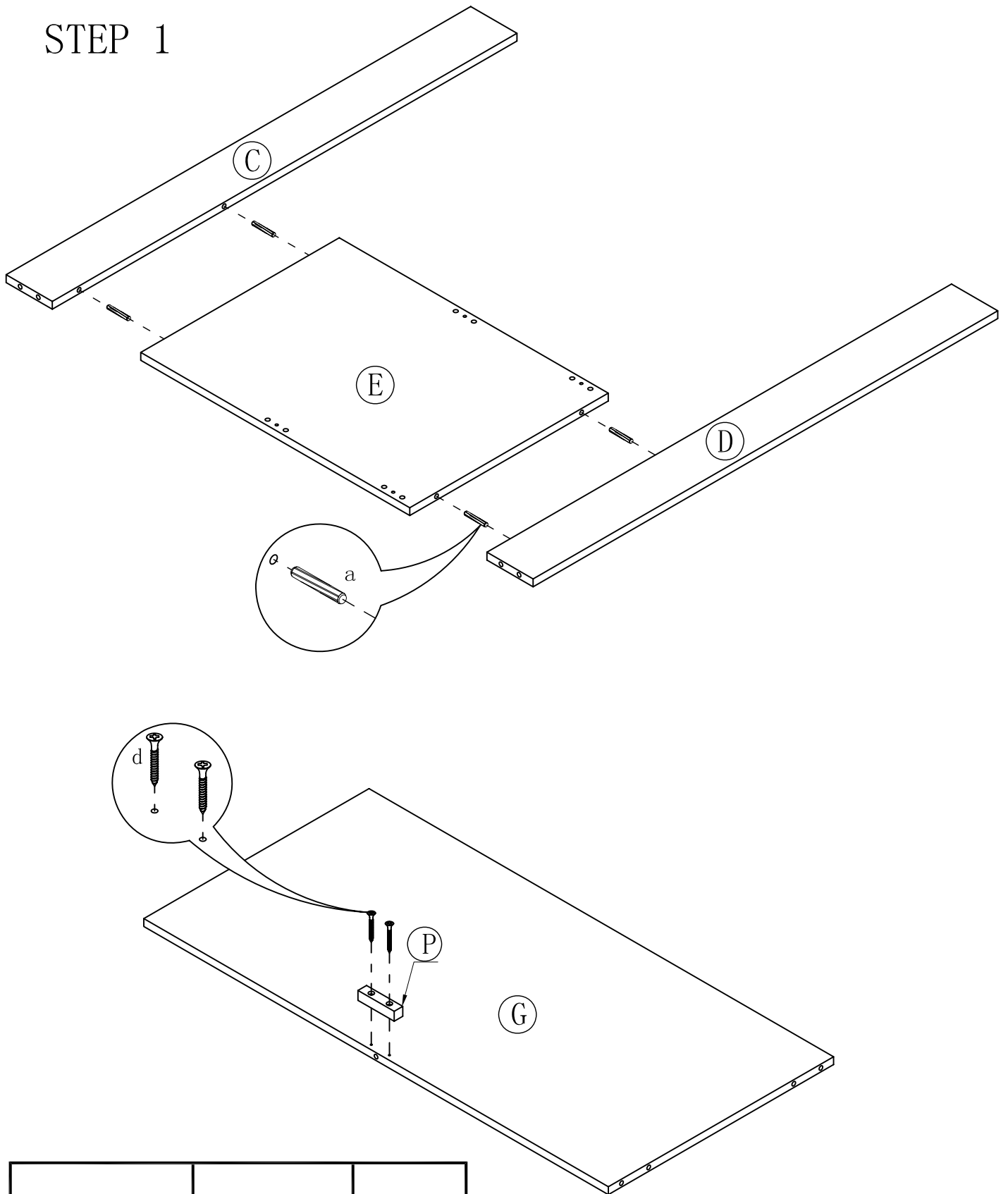

STEP 2

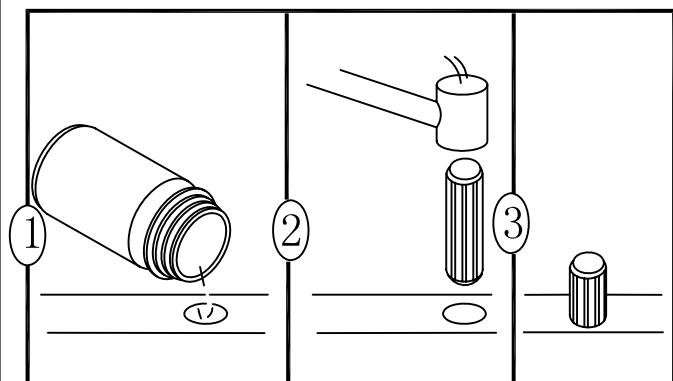
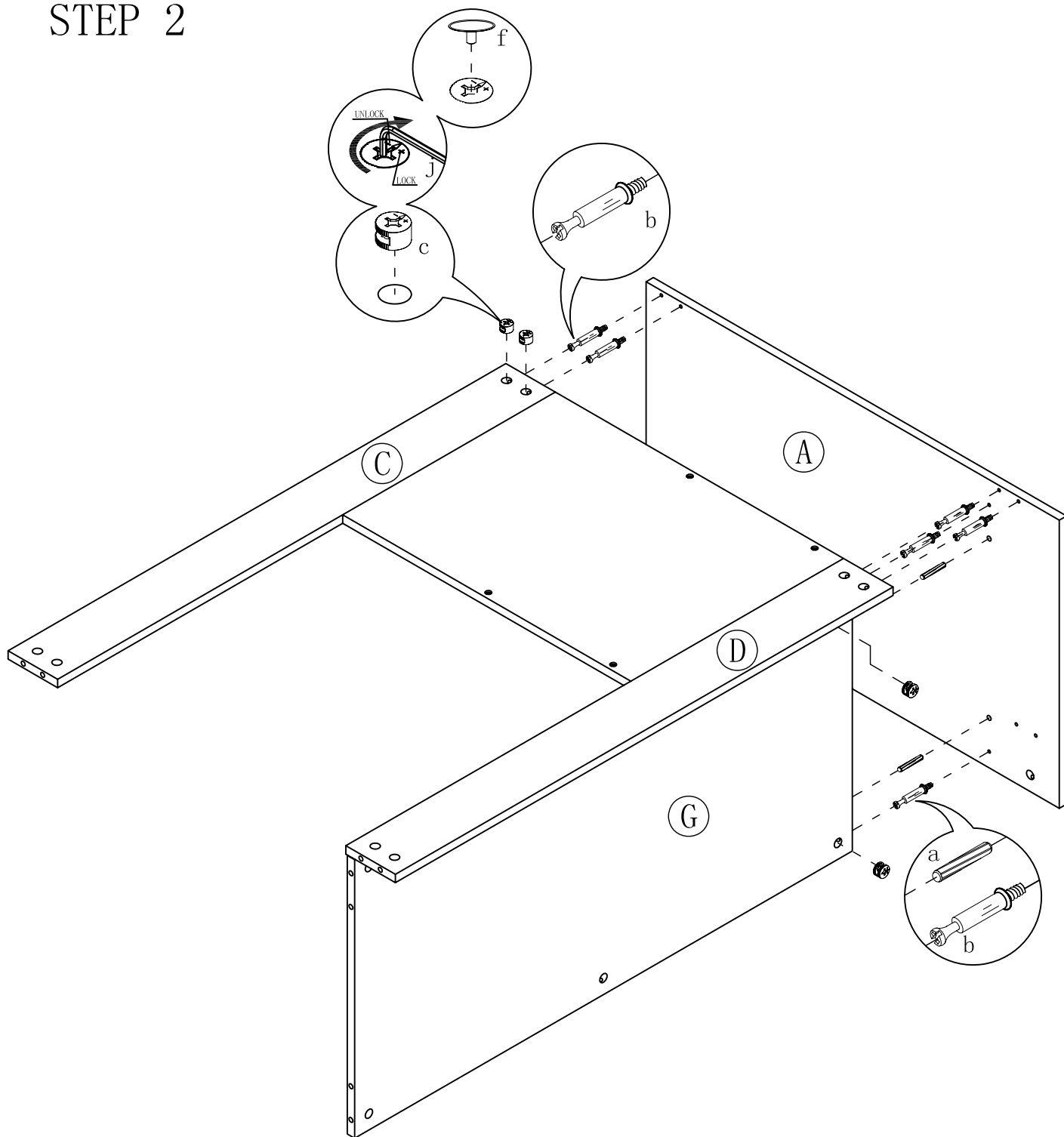

STEP 3

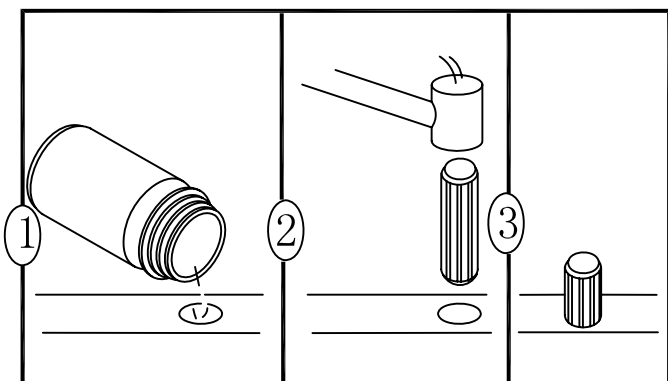
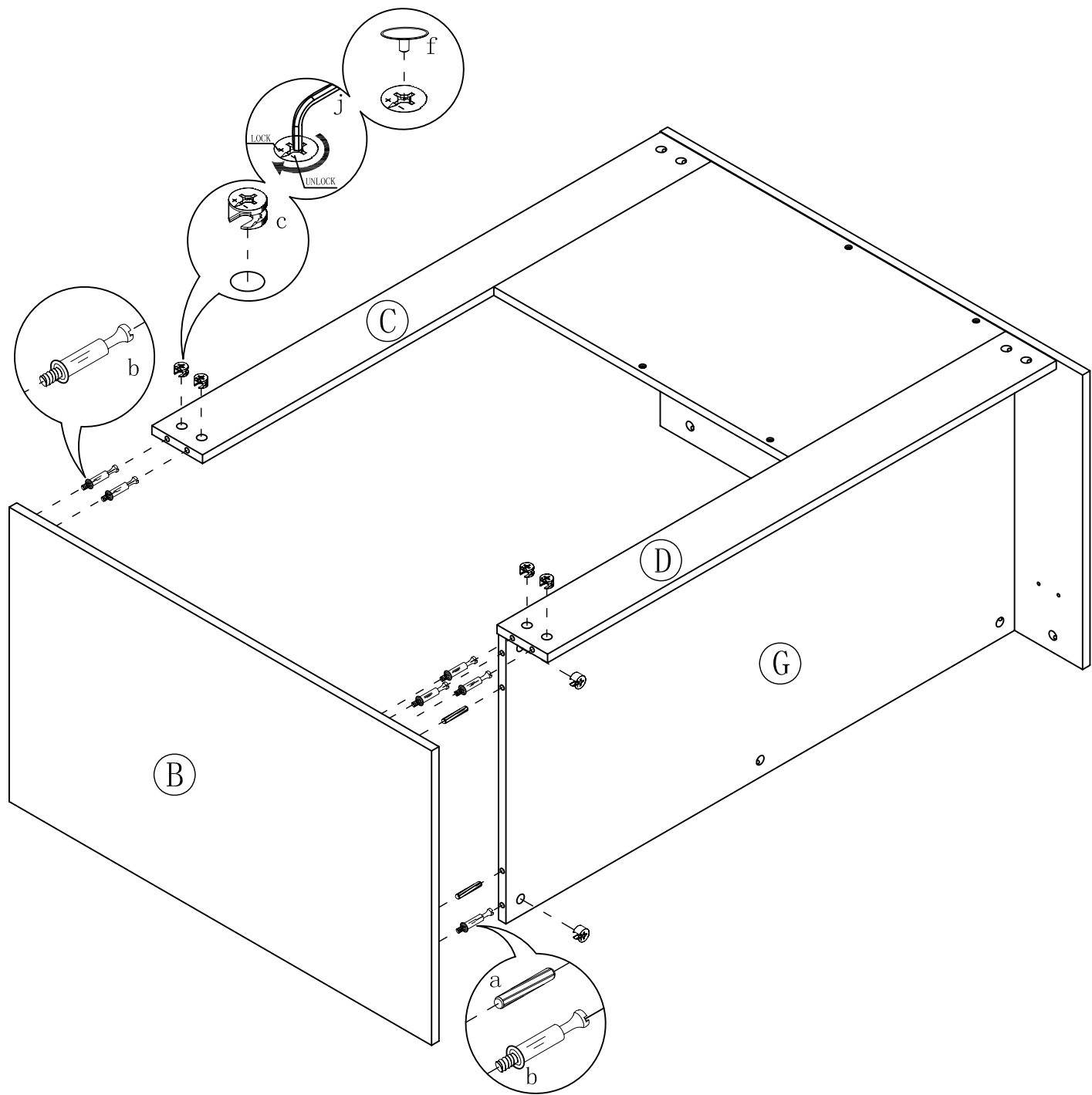

STEP 4

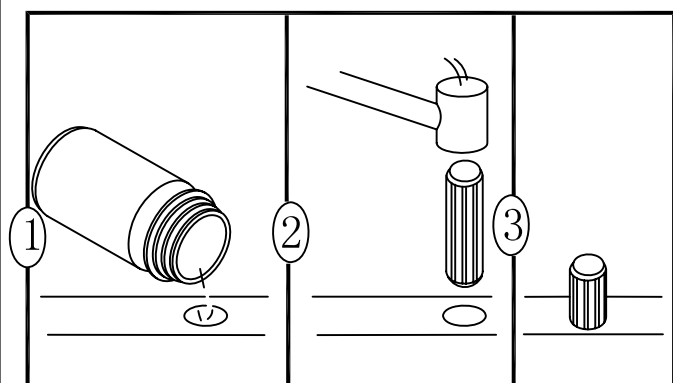
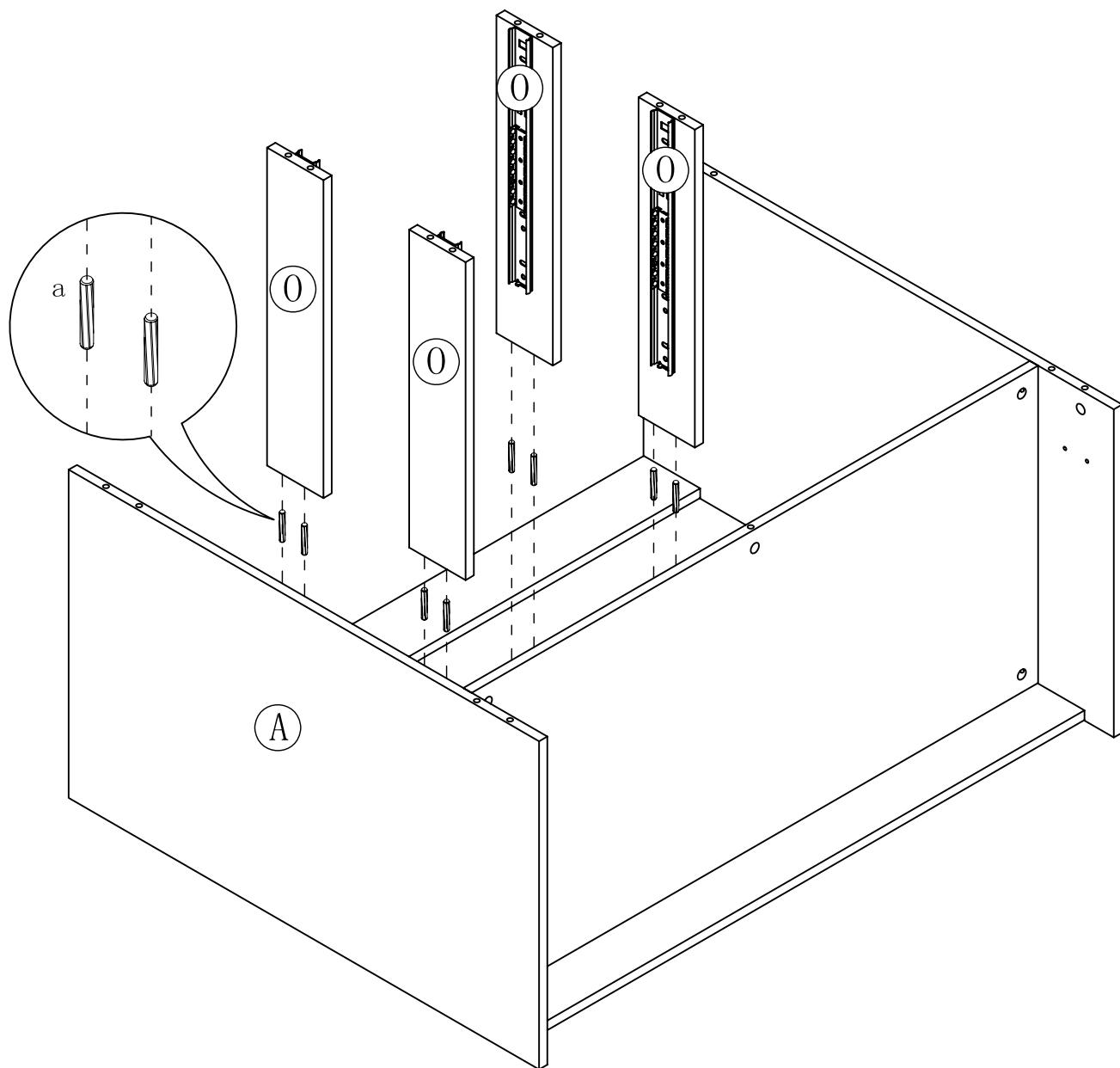

STEP 5

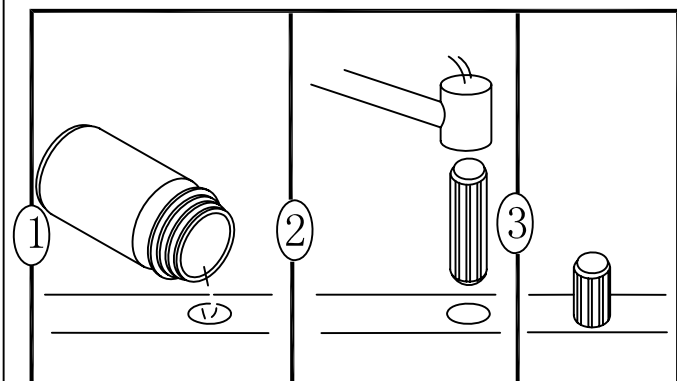
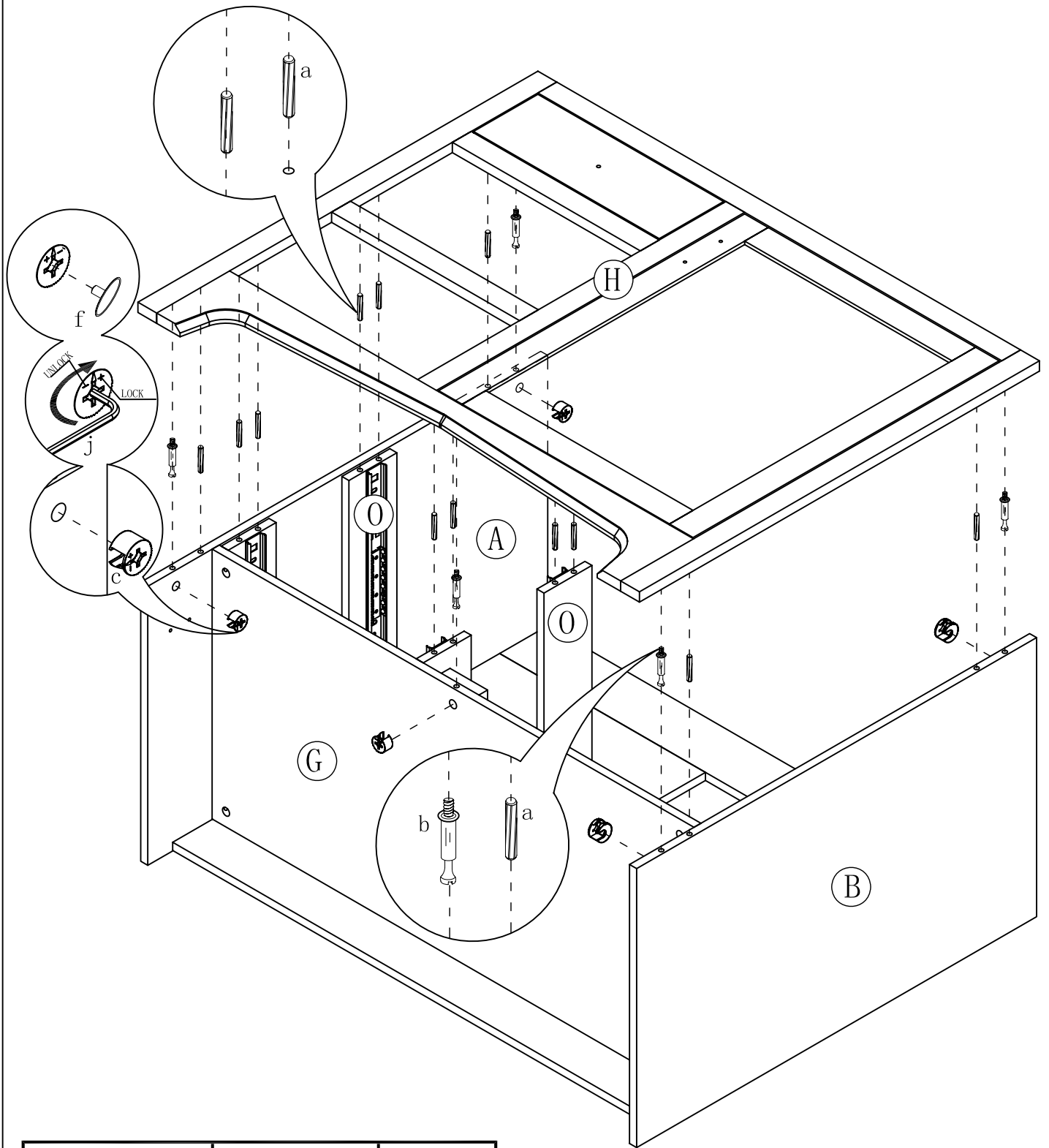

STEP 6

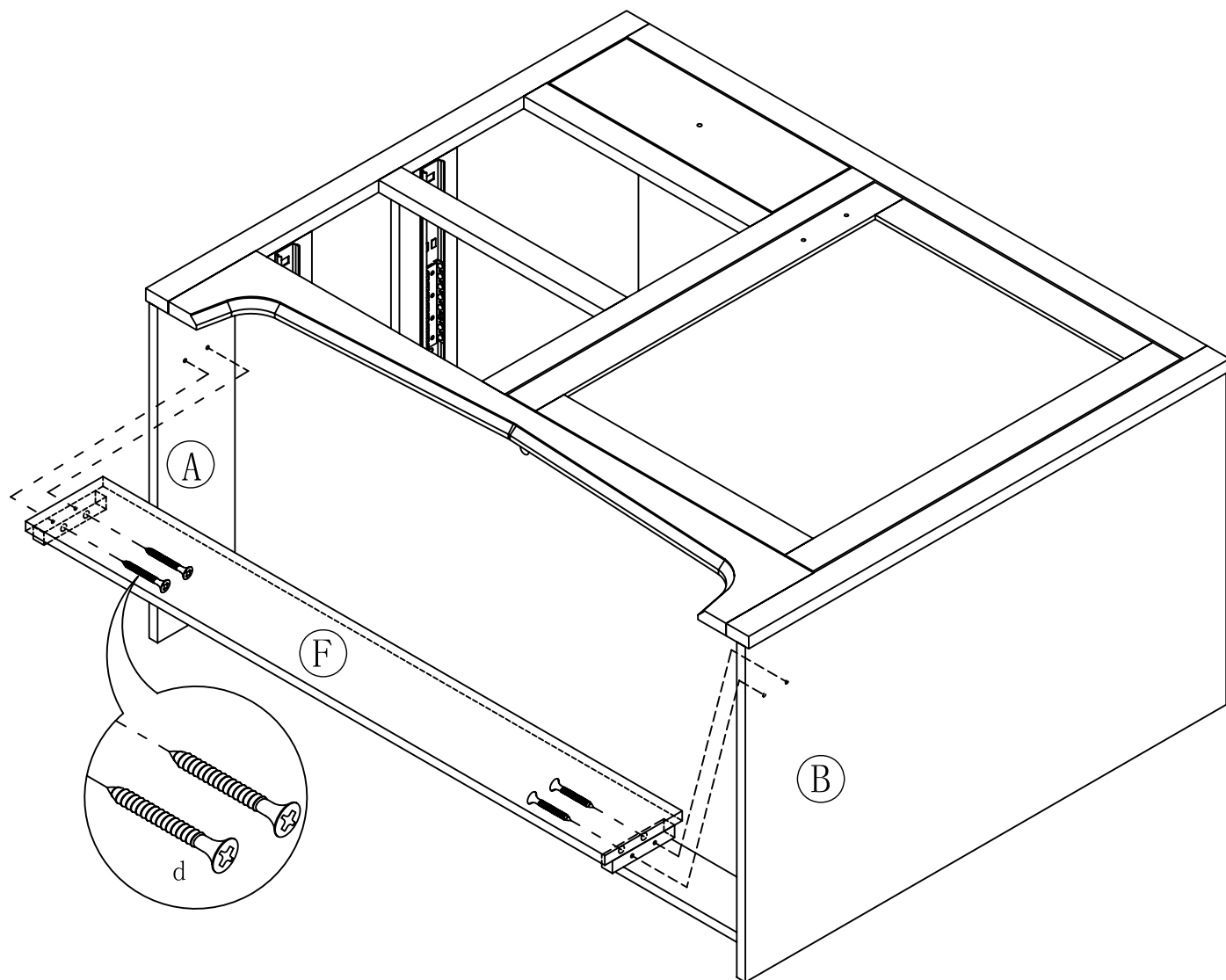

STEP 7

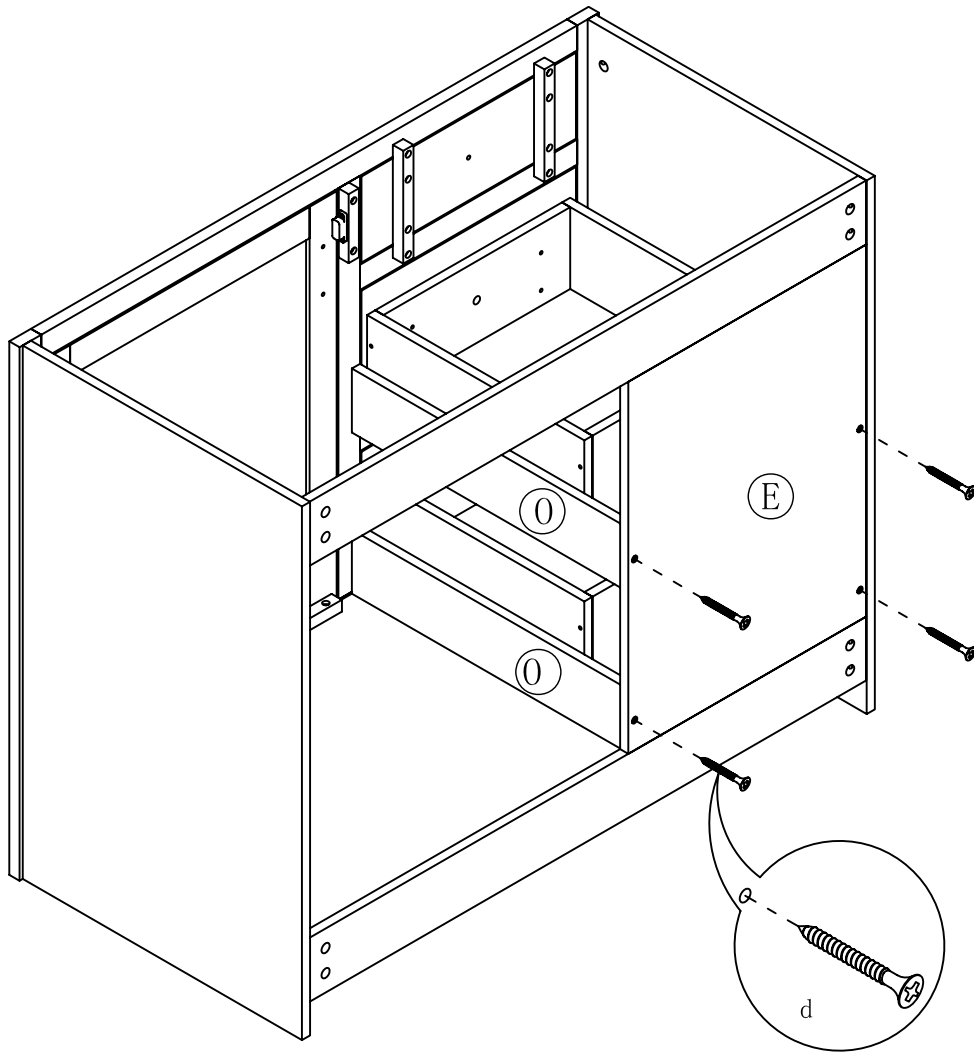

STEP 8

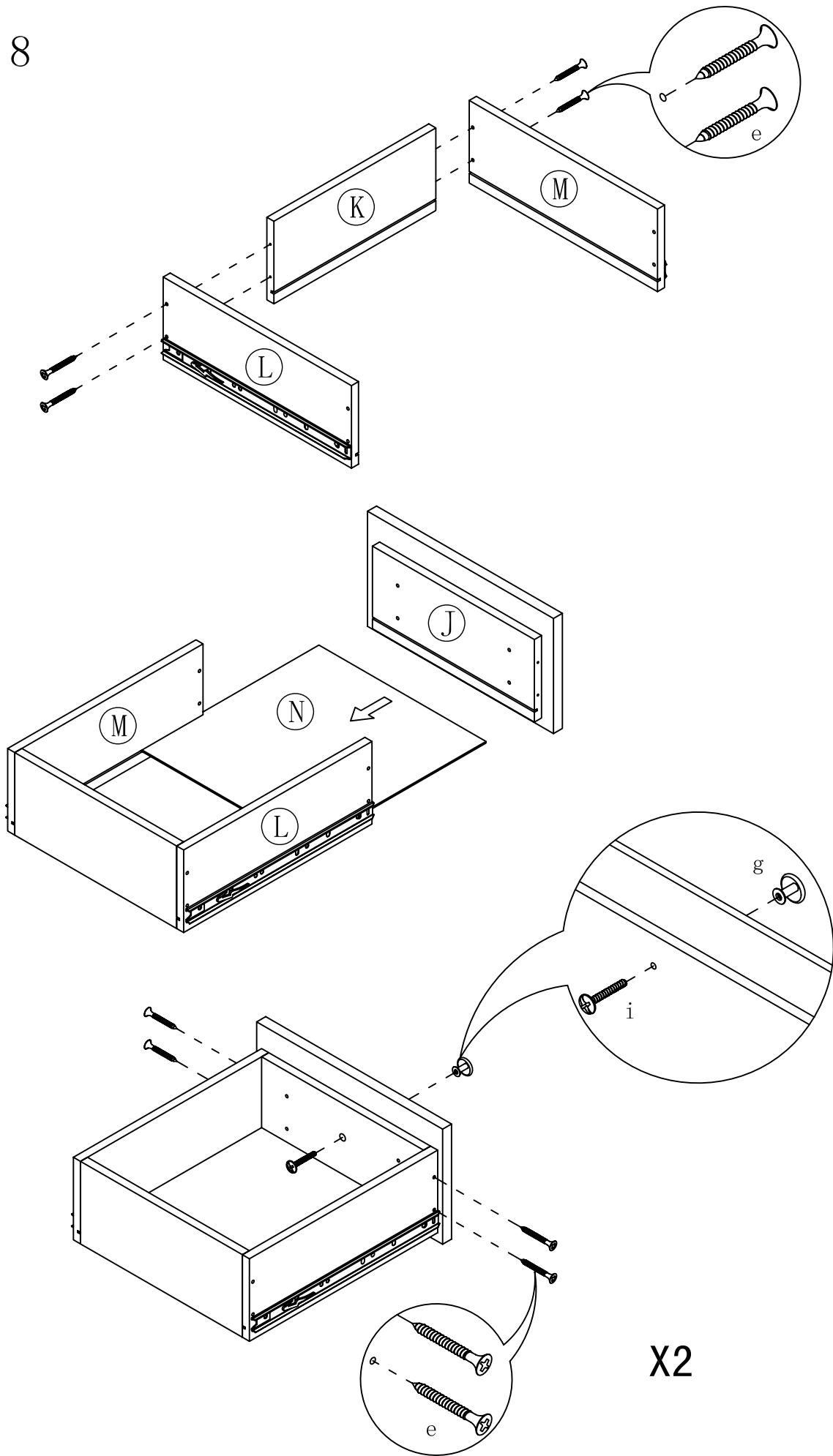

STEP 9

