

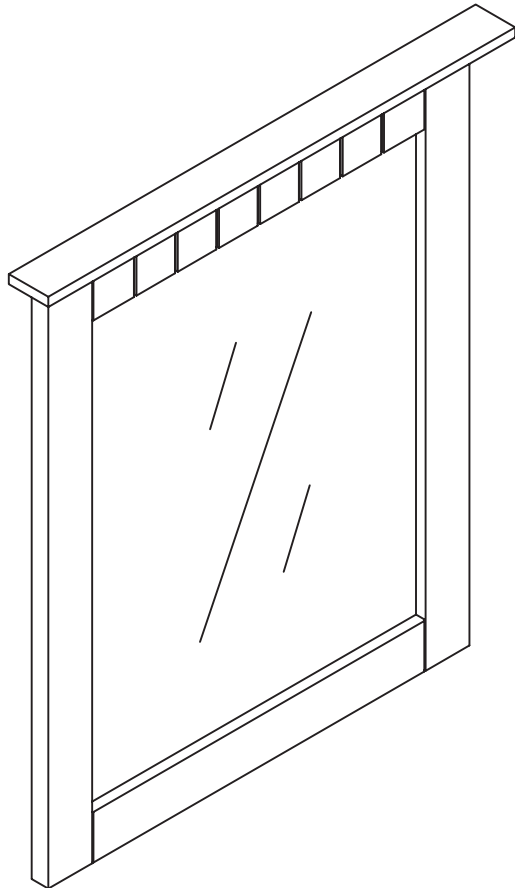

ADVANCED
GLOBAL COMMERCE



541581

ASSEMBLY INSTRUCTIONS

PARTS LIST:

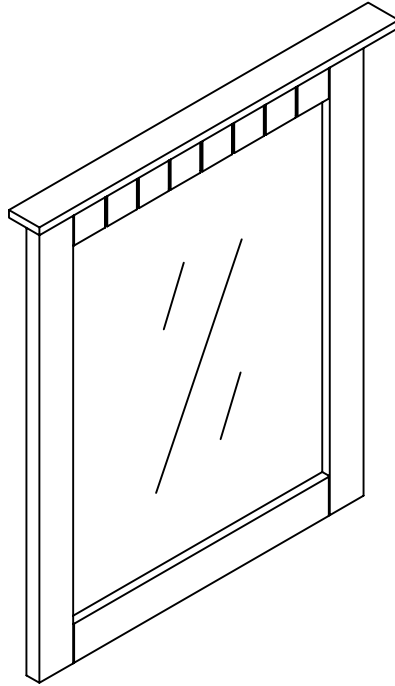

HARDWARE LIST:

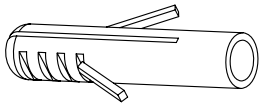

a. WALL ANCHOR 2PCS



b. 1-1/2" L FLAT HEAD SCREW 2PCS

STEP 1

