

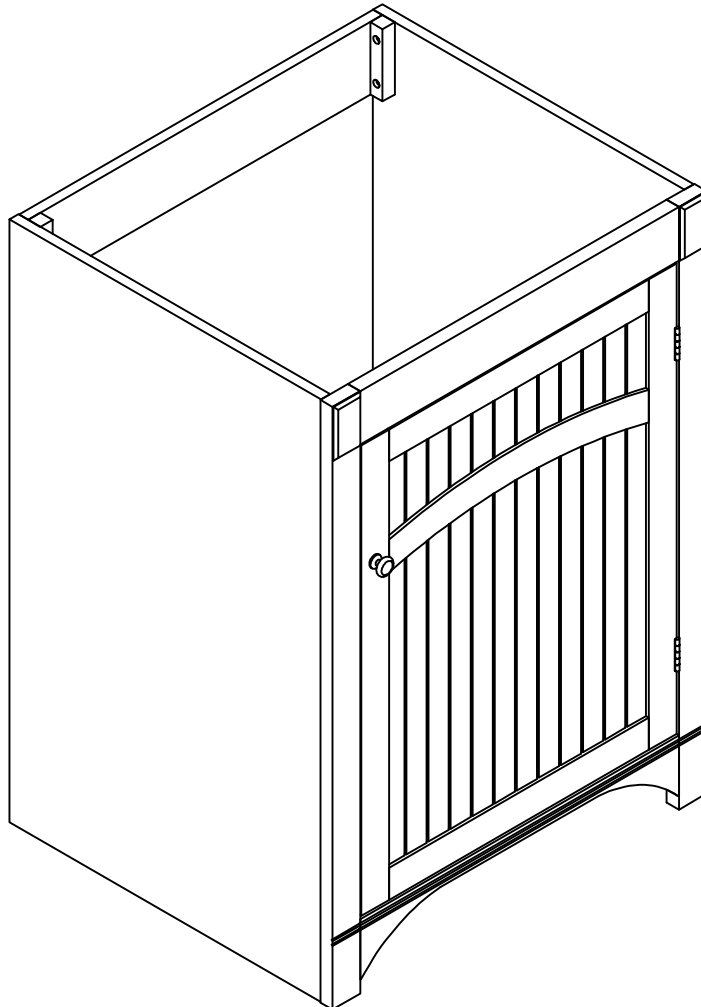

ADVANCED
GLOBAL COMMERCE



541557

ASSEMBLY INSTRUCTIONS

PARTS LIST:

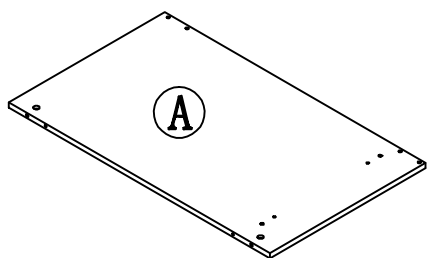

LEFT SIDE PANEL 1PC

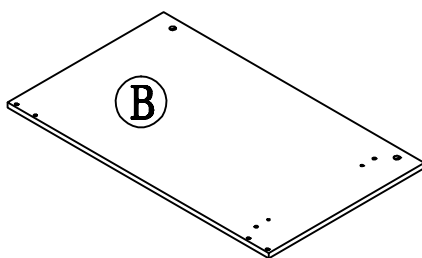

RIGHT SIDE PANEL 1PC

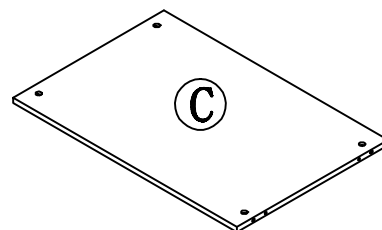

BOTTOM PANEL 1PC

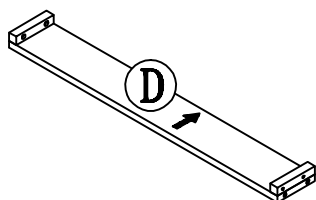

BACK UP PANEL 1PC

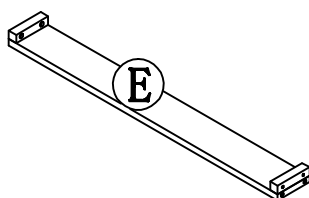

BACK DOWN PANEL 1PC

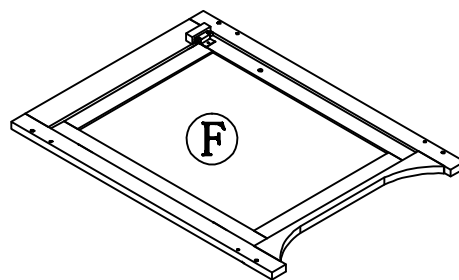

FRONT FRAME 1PC

HARDWARE LIST:



a. WOOD DOWEL 16PCS

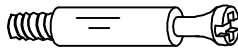

b. CAM LOCK SCREW 8PCS

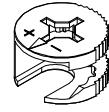

c. CAM LOCK 8PCS

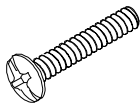

d. KNOB BOLT 1PC

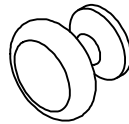

e. KNOB 1PC



f. FLAT HEAD SCREW 8PCS

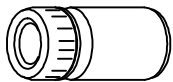

g. GLUE 1PC



h. WRENCH 1PC

STEP 1

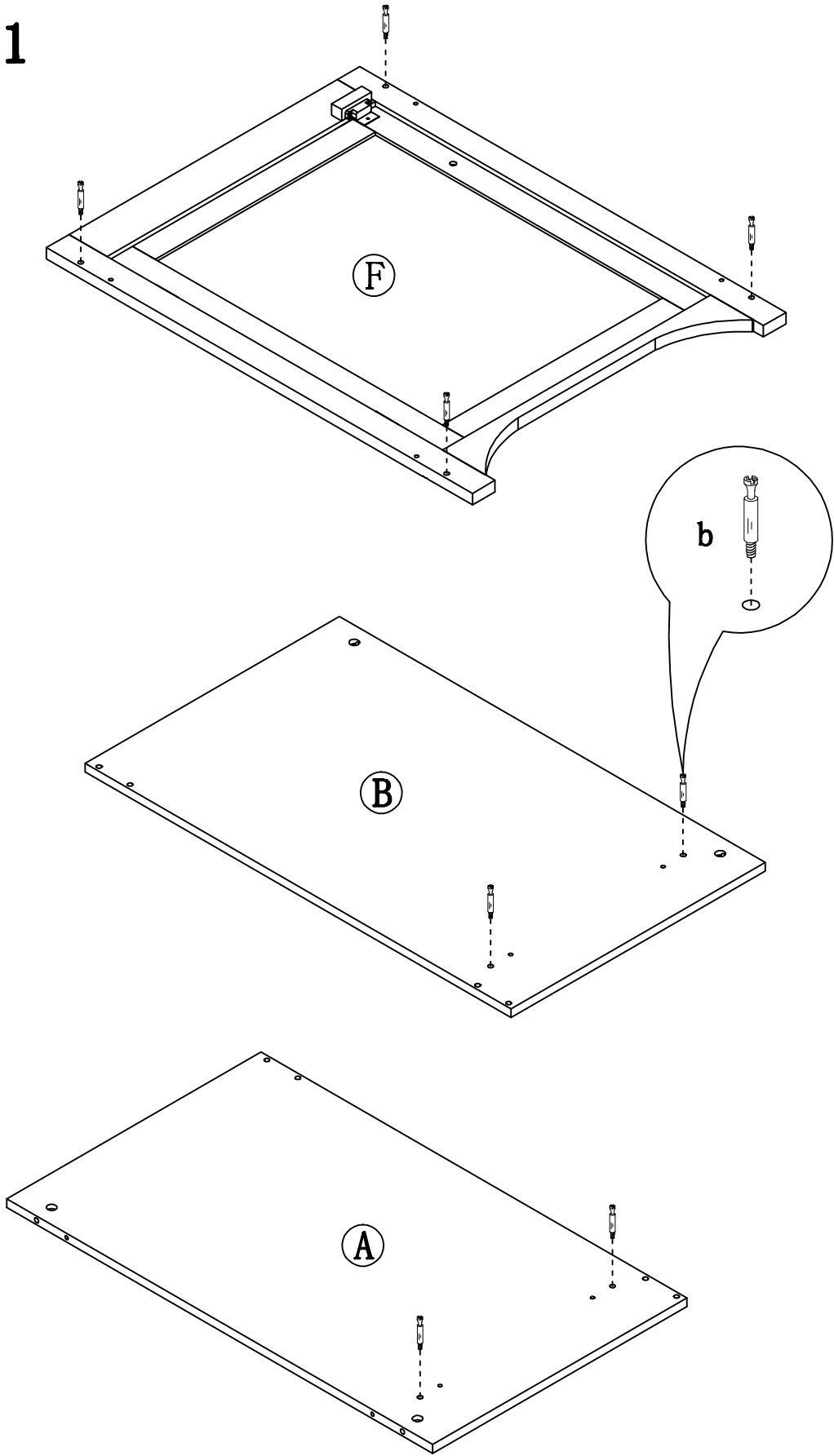

STEP 2

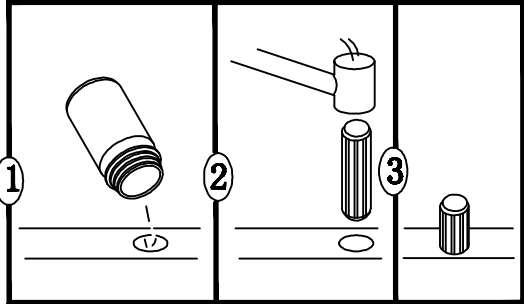
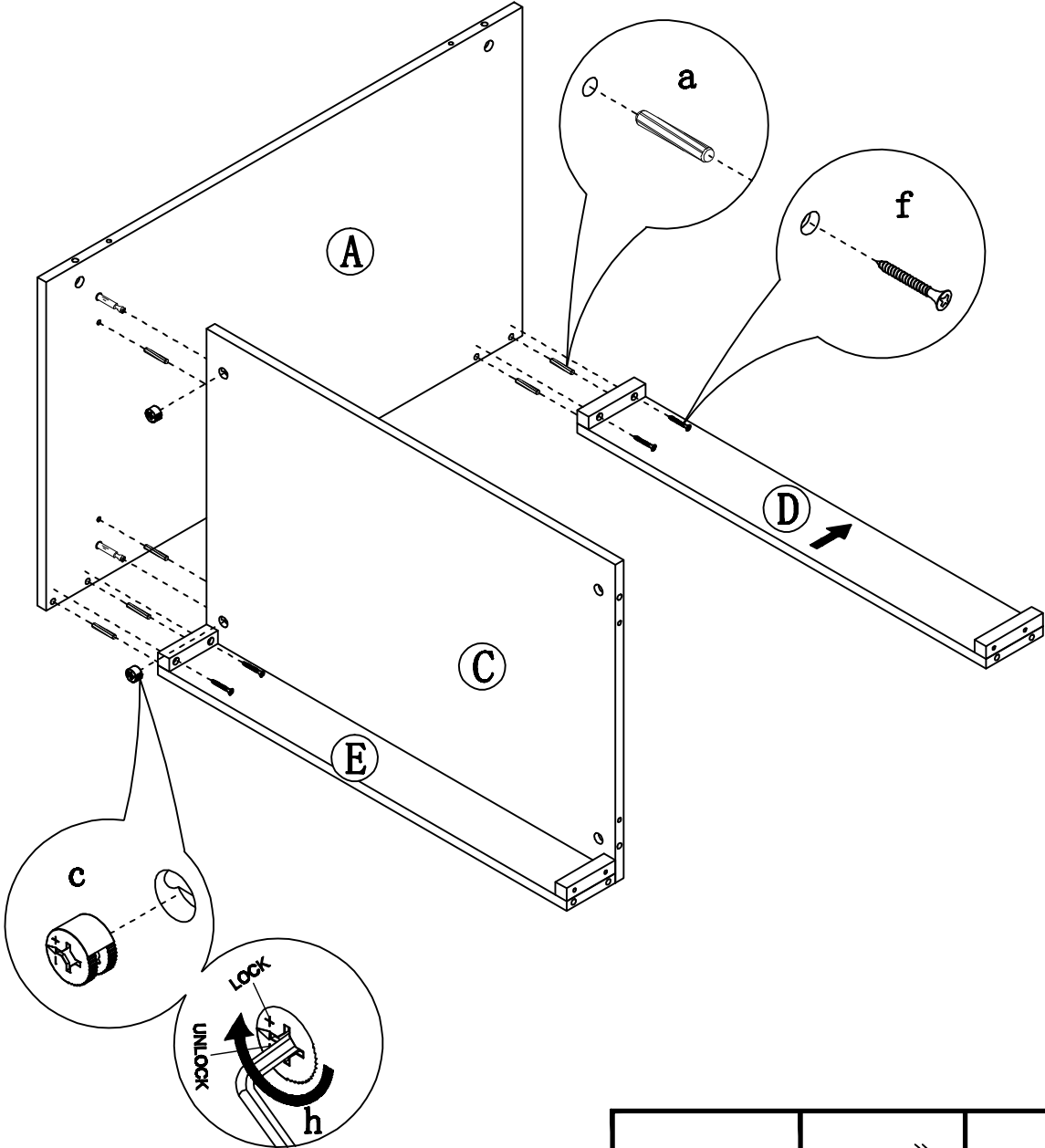

STEP 3

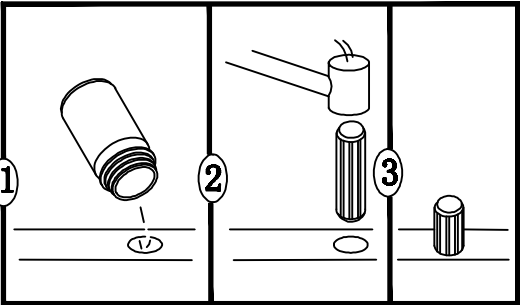
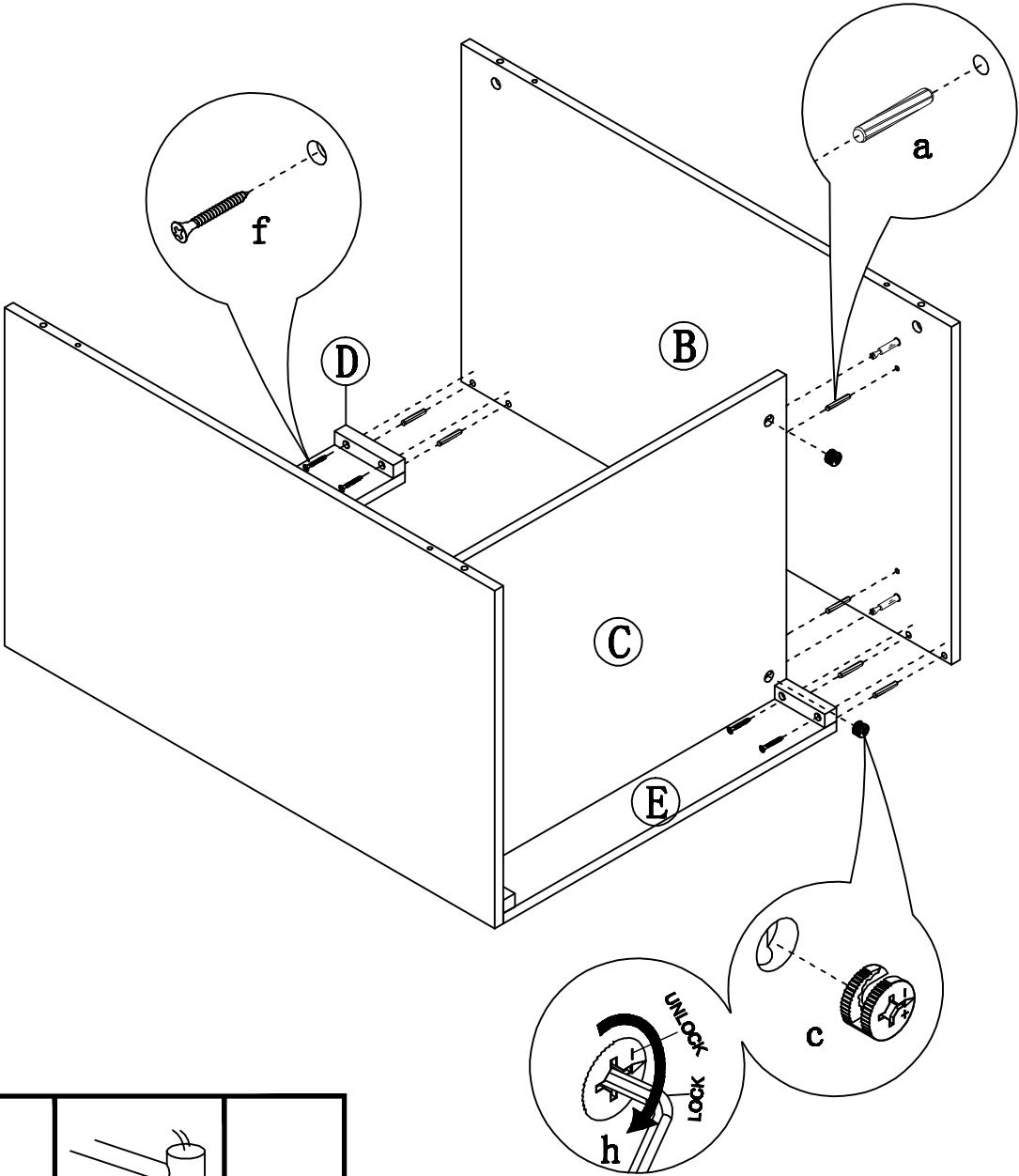

STEP 4

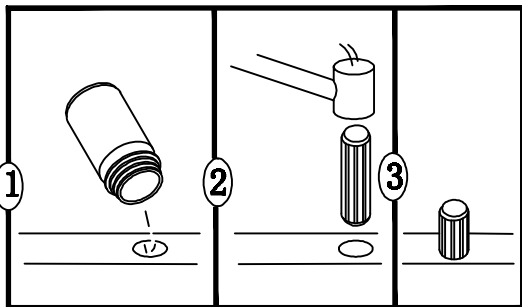
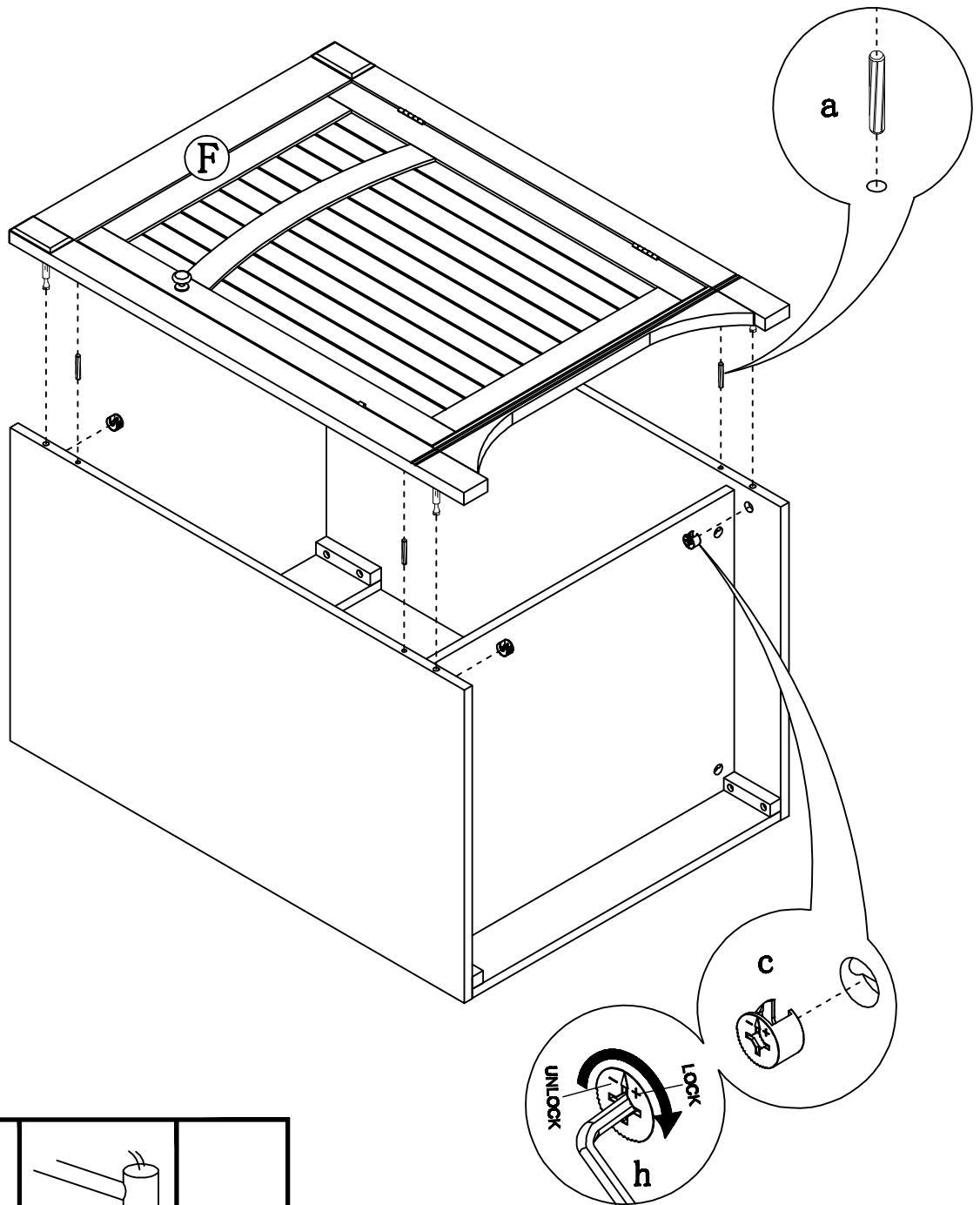

STEP 5

