

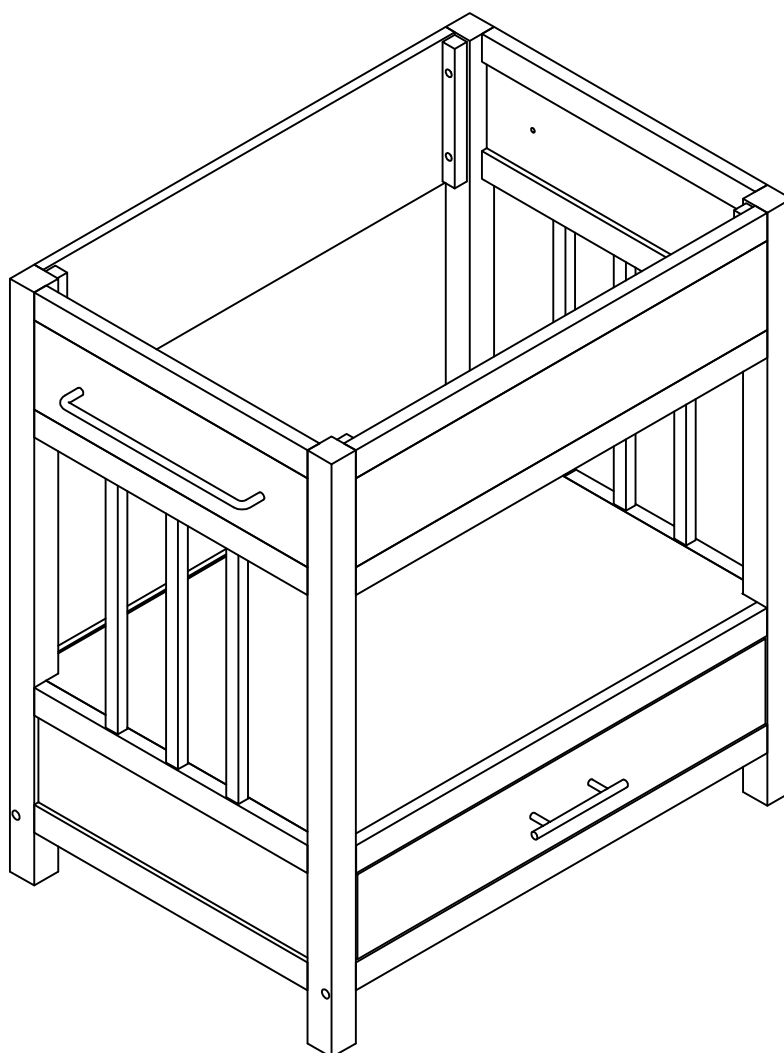

ADVANCED
GLOBAL COMMERCE



541516

ASSEMBLY INSTRUCTIONS

PARTS LIST:

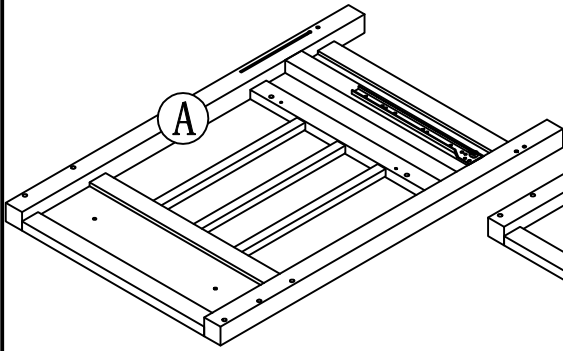

LEFT SIDE PANEL 1PC

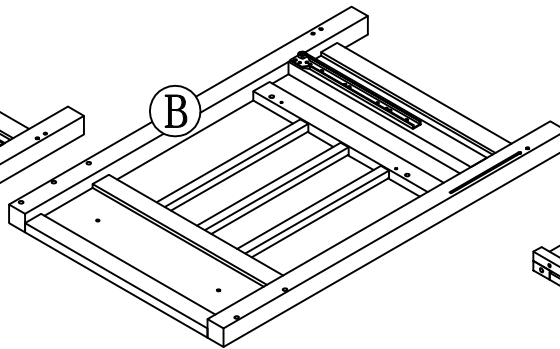

RIGHT SIDE PANEL 1PC

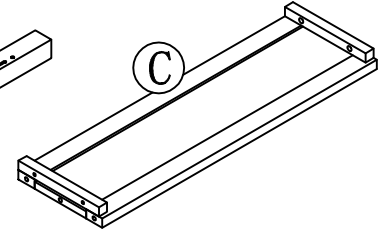

FRONT FRAME 1PC

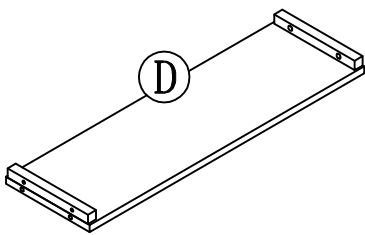

BACK UPPER PANEL 1PC

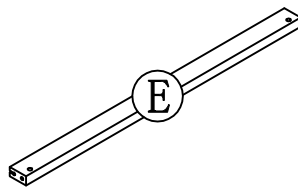

BACK LOWER CROSS BAR 1PC

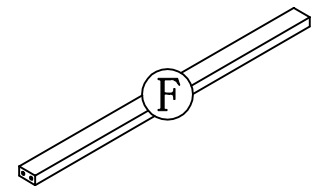

FRONT CROSS BAR 1PC

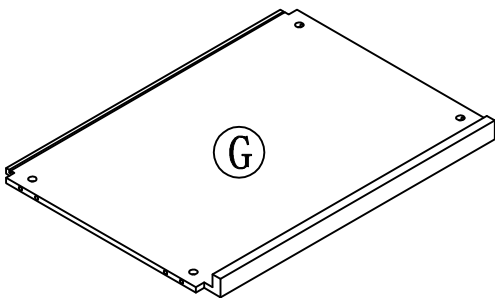

FIXED PANEL 1PC

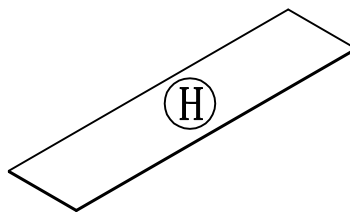

BACK PANEL 1PC

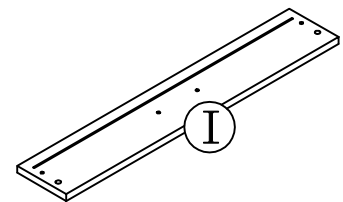

DRAWER FRONT PANEL 1PC

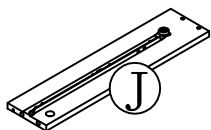

DRAWER LEFT SIDE
PANEL 1PC

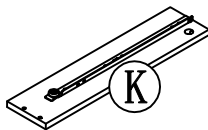

DRAWER RIGHT SIDE
PANEL 1PC

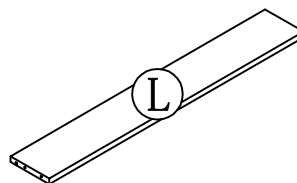

DRAWER BACK
PANEL 1PC

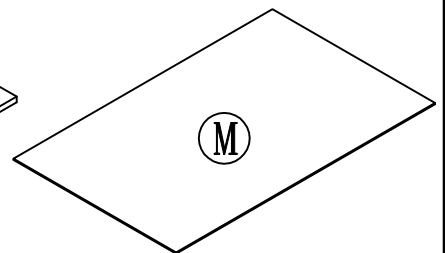

DRAWER BOTTOM
PANEL 1PC

HARDWARE LIST:



a. WOOD DOWEL 18PCS

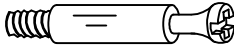

b. CAM LOCK SCREW 6PCS



c. CAM LOCK 6PCS



d. PHILIP HEAD SCREW 4PCS



e. FLAT HEAD SCREW 12PCS

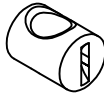

f. 4PCS

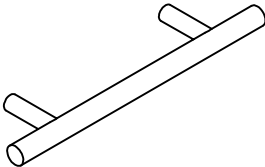

g. HANDLE (1) 1PC

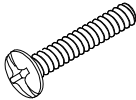

h. $\phi 5/32$ " HANDLE BOLT 2PCS

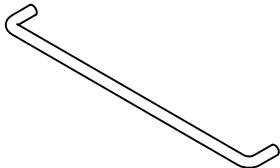

i. HANDLE (2) 2PCS

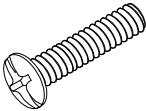

j. $\phi 3/16$ " HANDLE BOLT 4PCS



k. WOOD PLUG 4PCS

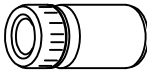

l. GLUE 1PC



m. WRENCH 1PC

STEP 1

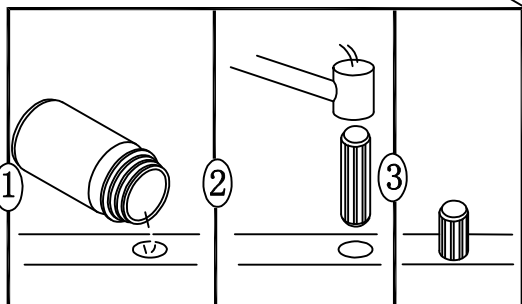
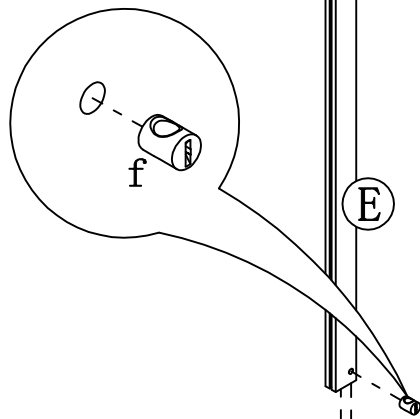
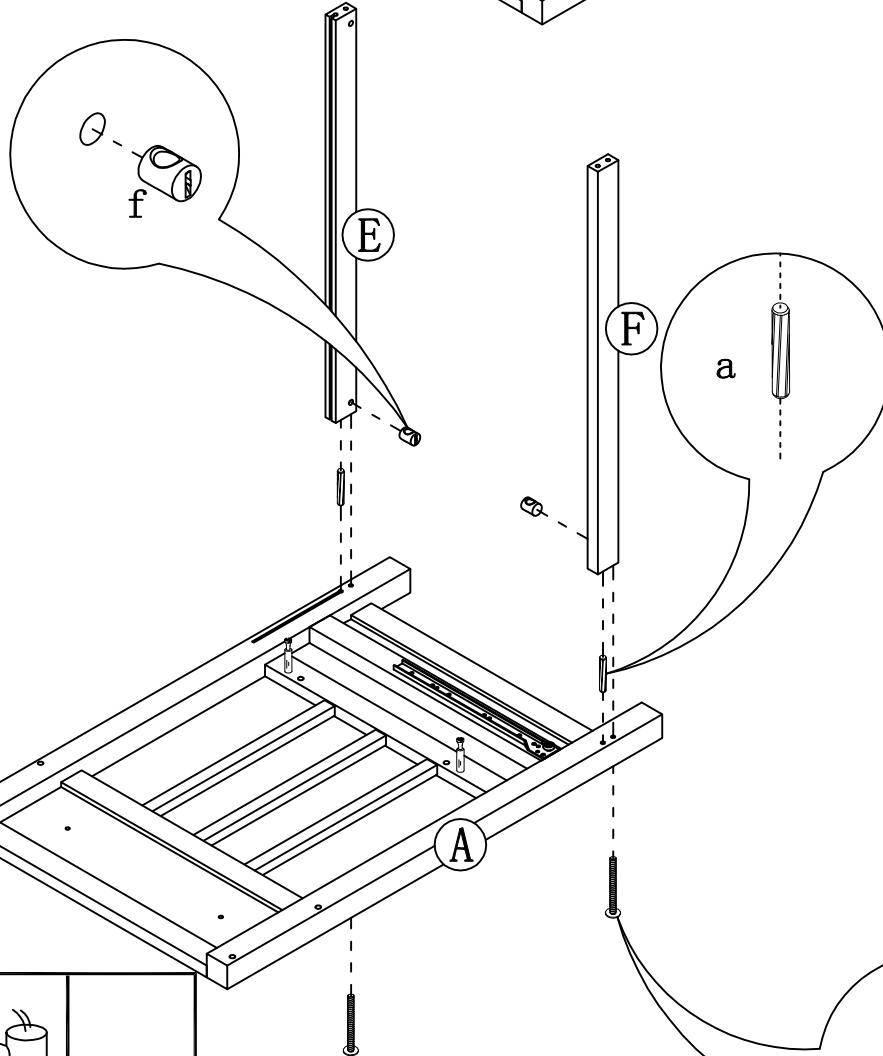
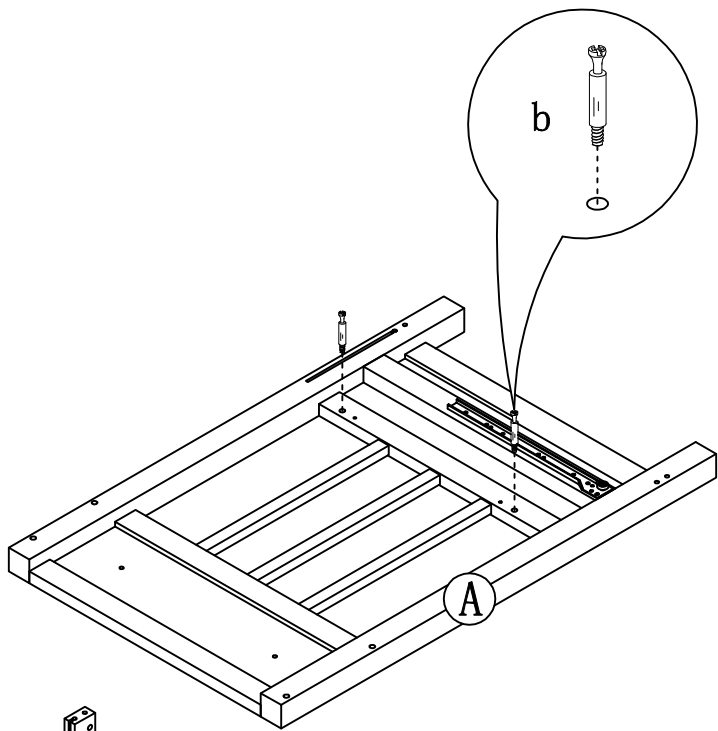

STEP 2

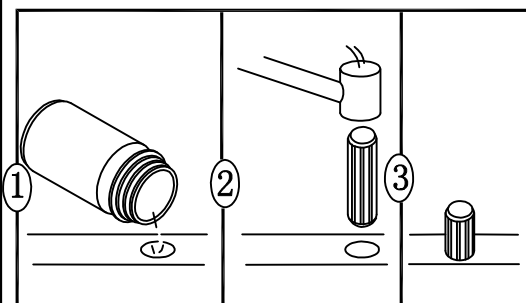
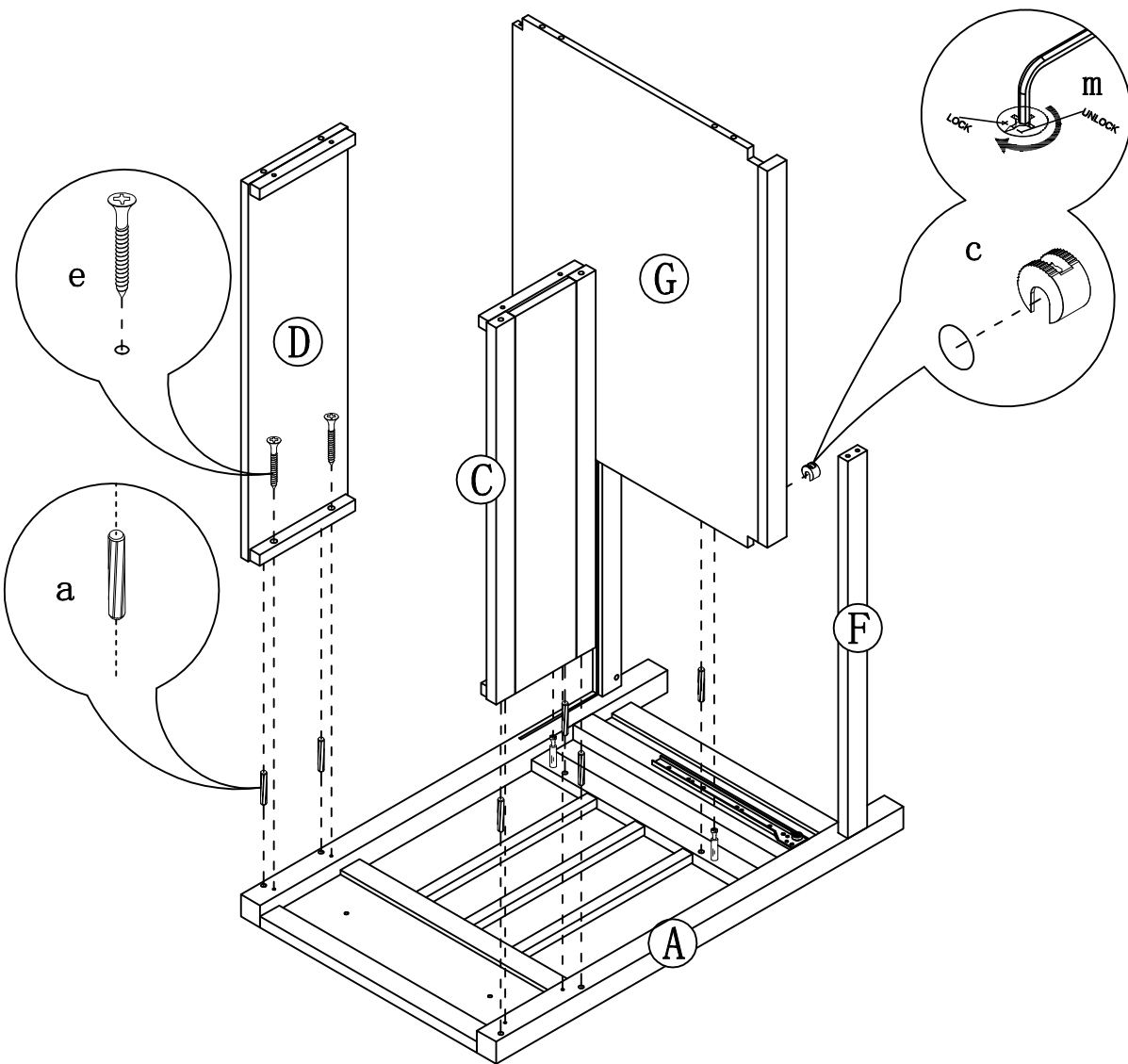

STEP 3

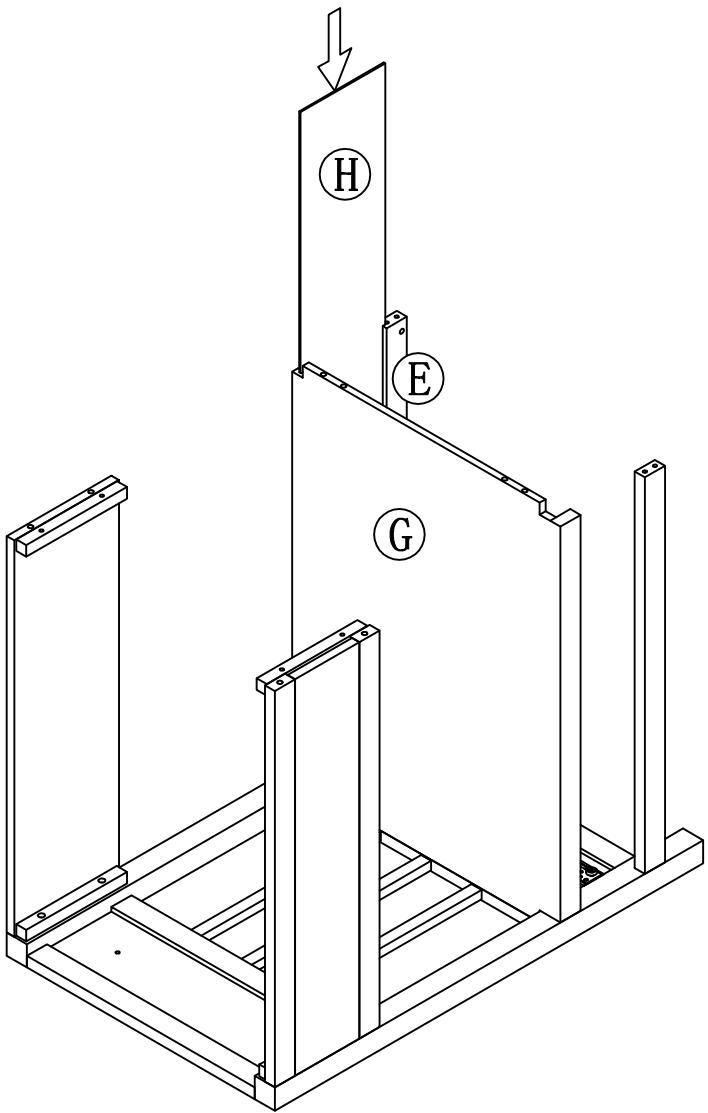

STEP 4

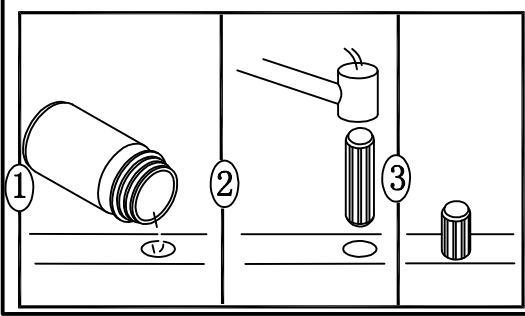
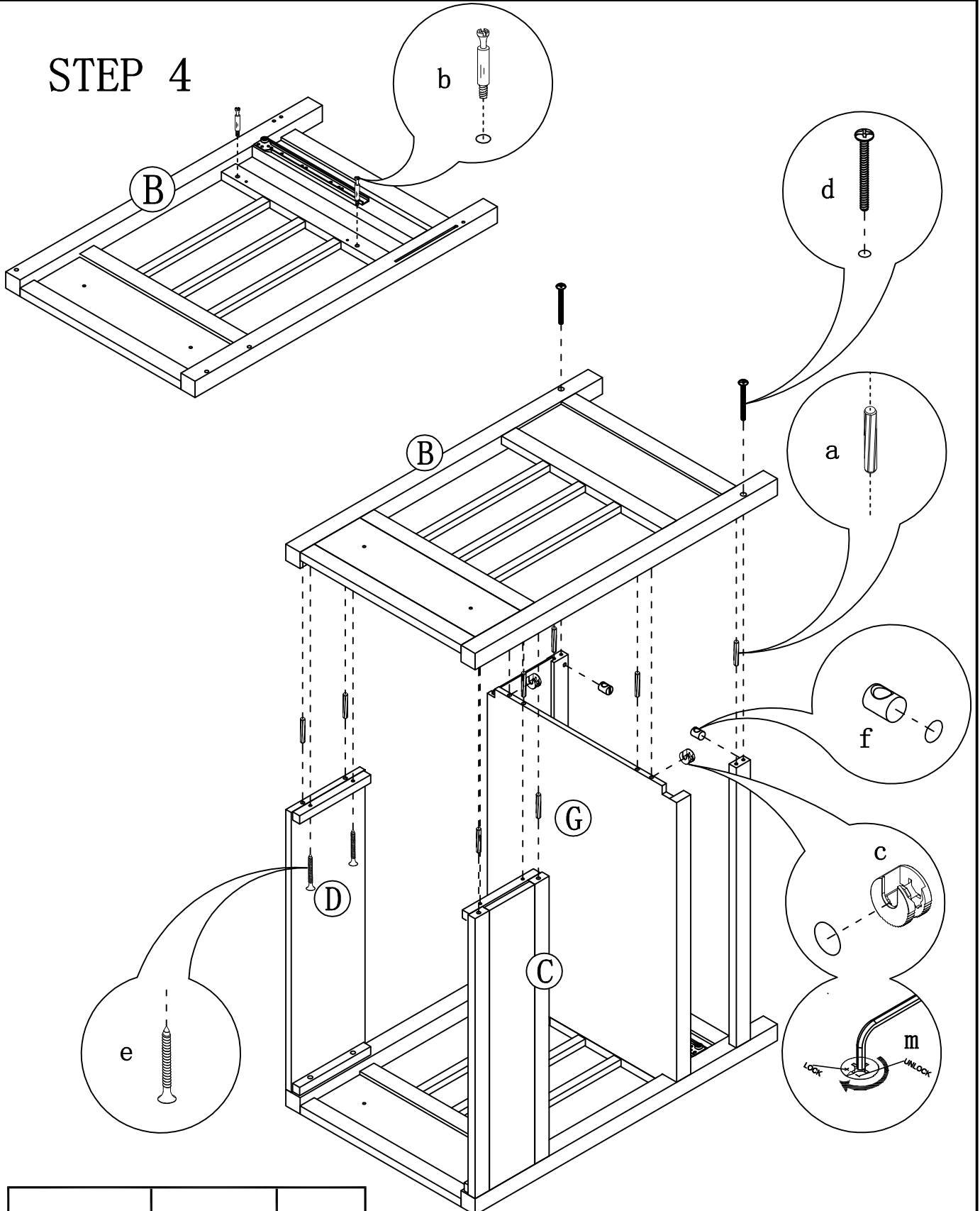

STEP 5

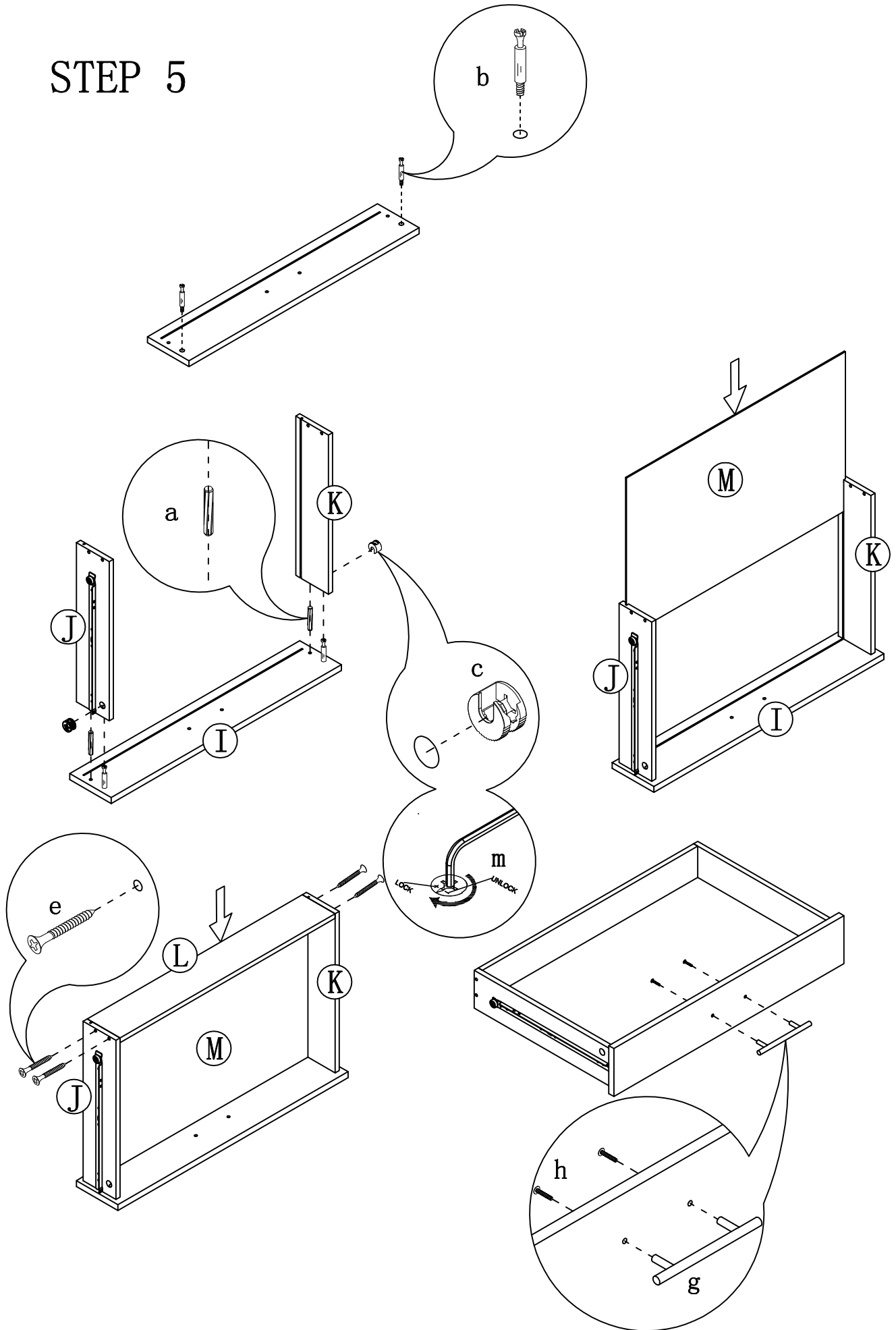

STEP 6

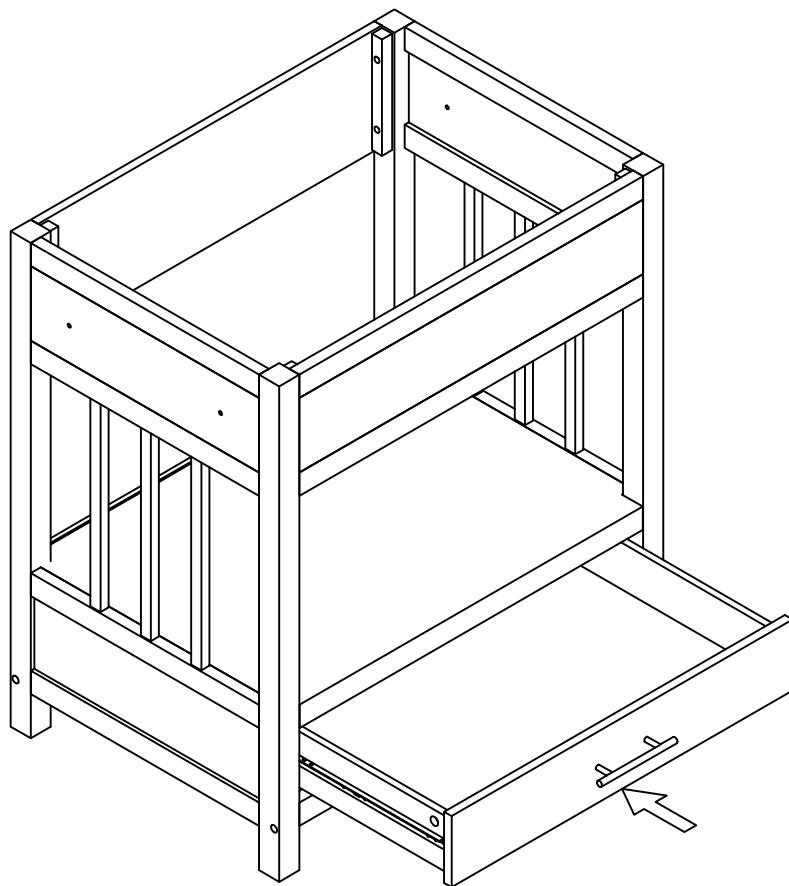

STEP 7

